



# Guidelines for Bar Code Symbol Placement



# **Guidelines for Bar Code Symbol Placement**

*Revised: May 2007*

© 2007 GS1 US™

## **Disclaimer**

GS1 US, Inc.<sup>™</sup> is providing this application guideline as a service to interested industries. This application guideline was developed through a consensus process of interested parties.

Although efforts have been made to assure that the application guideline is correct, reliable, and technically accurate, GS1 US makes NO WARRANTY, EXPRESS OR IMPLIED, THAT THIS APPLICATION GUIDELINE IS CORRECT, WILL NOT REQUIRE MODIFICATION AS EXPERIENCE AND TECHNOLOGICAL ADVANCES DICTATE, OR WILL BE SUITABLE FOR ANY PURPOSE OR WORKABLE IN ANY APPLICATION, OR OTHERWISE. Each user of the application guideline assumes all risk and responsibility for its use of the materials.

Use of this application guideline is with the understanding that GS1 US accepts no liability whatsoever for any direct, indirect, special or other consequential damages of whatever kind resulting from whatever cause through the use of the application guideline or any information therein, even if GS1 US has been advised of the possibility of such damages.

## **IAPMO**

In this publication, the letters "U.P.C." are used solely as an abbreviation for the "Universal Product Code" which is a product identification system. They do not refer to the UPC, which is a federally registered certification mark of the International Association of Plumbing and Mechanical Officials (IAPMO) to certify compliance with a Uniform Plumbing Code as authorized by IAPMO.

## **About GS1 US**

GS1 US, Inc. is a not-for-profit organization dedicated to the adoption and implementation of standards-based, global supply chain solutions. GS1 US operates subsidiaries EPCglobal North America<sup>™</sup>, RosettaNet, and 1SYNC<sup>™</sup>. GS1 US manages the United Nations Standard Products and Services Code<sup>®</sup> (UNSPSC<sup>®</sup>) for the UN Development Programme. EPCglobal Inc<sup>™</sup> is a joint venture of GS1 US and GS1<sup>®</sup>. GS1 US-based solutions, including business processes, XML standards, EDI transaction sets, and the bar code identification standards of the GS1 System are currently used by more than one million companies worldwide. For more information, visit [www.gs1us.org](http://www.gs1us.org)

## Table of Contents

<b>1</b>	<b>Introduction .....</b>	<b>4</b>
<b>2</b>	<b>General Placement Principles .....</b>	<b>5</b>
2.1	Number of Symbols .....	5
2.2	Scanning Environment.....	5
2.3	Orientation .....	5
<b>3</b>	<b>General Placement Guidelines for Point-of-Sale.....</b>	<b>8</b>
3.1	Number of Symbols .....	8
3.2	Identifying the Back of the Trade Item .....	8
3.3	Symbol Placement.....	8
<b>4</b>	<b>Placement Guidelines for Specific Package Types.....</b>	<b>14</b>
4.1	Bags.....	15
4.2	Blister Packs .....	16
4.3	Bottles and Jars .....	17
4.4	Boxes .....	18
4.5	Cans and Cylinders.....	19
4.6	Carded Items .....	20
4.7	Egg Cartons.....	20
4.8	Jugs .....	21
4.9	Large, Heavy, or Bulky Items.....	22
4.10	Multi-packs .....	25
4.11	Publishing Items .....	26
4.12	Thin Items or Containers .....	29
4.13	Trays.....	30
4.14	Tubes.....	30
4.15	Tubs.....	31
4.16	Unpackaged Items.....	32
4.17	Sets (Grouping of individually bar coded items) .....	34
4.18	Sporting Goods.....	36
4.19	Textured Surfaces .....	48
<b>5</b>	<b>Symbol Placement for Clothing and Fashion Accessories.....</b>	<b>49</b>
<b>6</b>	<b>General Format Guidelines for Clothing and Fashion Accessories.....</b>	<b>67</b>
6.1	Information Zones Concept.....	67
6.2	Hang Tag (Hanging Label) Format .....	70
6.3	Sewn-On (Joker) Label Format.....	72
6.4	Sewn-In Label Formats.....	74
6.5	Plastic Packaged Products Label Location Guidelines.....	75
6.6	Boxed Products Label Formats.....	79
6.7	Banded Products Label Formats .....	82
<b>7</b>	<b>General Placement Guidelines for Items Used in Distribution .....</b>	<b>85</b>
7.1	General Rule.....	85
7.2	Add-On Symbols.....	89
<b>Appendix A:</b>	<b>General Rules for Curved Surfaces .....</b>	<b>90</b>

# 1 Introduction

This section includes guidelines for the placement of bar code symbols on packages and containers. It provides the general principles that apply, mandatory rules, and recommendations for symbol placement on specific packaging and container types.

Consistency of symbol placement is critical to successful scanning. With manual scanning, variation of symbol placement makes it difficult for the scanning operator to predict where the symbol is located, and this reduces efficiency. With automated scanning, the symbol must be positioned so that it will pass through the field of vision of a fixed scanner as it travels past. Respecting the guidance in this section will result in the consistency and predictability required.

The guidelines in this global specification replace previous local recommendations; however, manufacturers should not scrap packaging that has been printed according to a previous guidance. When packaging is redesigned, observe the global specifications in this document.

If government regulatory guidelines are inconsistent with those in this manual, the government guidelines always take precedence.

**NOTE:** Bar code symbols in this guideline that are used as examples are For Position Only (FPO) and are not intended to denote correct symbol type, size, color, or quality.

## 2 General Placement Principles

The following general principles for bar code symbol placement should be considered for any package type, whether it is scanned at the point-of-sale (POS) or elsewhere in the supply chain. Trade items intended to be scanned at a POS must be marked with an EAN-13, UPC-A, EAN-8, or UPC-E bar code symbol. The bar code symbols that are scanned elsewhere are the EAN-13, UPC-A, ITF-14, and GS1-128 bar code symbols.

EAN-8 and UPC-E bar code symbols are intended for use on very small trade items sold at the POS.

### 2.1 Number of Symbols

Bar code symbols representing different Global Trade Item Numbers<sup>®</sup> (GTINs<sup>®</sup>) must never be visible on any one item. Although a minimum of one is required, two symbols representing the same GTIN are recommended on trade items for scanning in warehousing or General Distribution Scanning environments (see *Section 7*). Two or more symbols representing the same GTIN are recommended on heavy or bulky items for POS (see *Section 4.9*) and are permissible on random wraps intended for POS (see *Section 3.3.6*).

### 2.2 Scanning Environment

Before considering the package type, determine whether the item will be scanned in a POS or a General Distribution Scanning environment. If the item is scanned at a POS only, the bar code symbol placement guidelines in *Sections 4* and *5* apply. However, if the item is scanned in both a POS and General Distribution Scanning environment or in a General Distribution Scanning environment only, the requirements in *Section 7* take precedence.

### 2.3 Orientation

Bar code symbol orientation is determined primarily by the print process and any curvature of the item. If the printing process and curvature allow, the preferred placement is picket fence orientation rather than ladder orientation; that is, the bars of the bar code symbol should be perpendicular to the surface on which the package stands in its normal display position. On a picket fence orientation bar code symbol, the human readable characters beneath the symbol should read from left to right. The text and orientation of the ladder orientation bar code symbol can be read either from the top down, or from the bottom up, whichever is consistent with other text and graphics on the container. Empirical data demonstrates that it makes no difference to the scanning process one way or the other. See *Appendix A* for rules for positioning bar code symbols on curved surfaces.

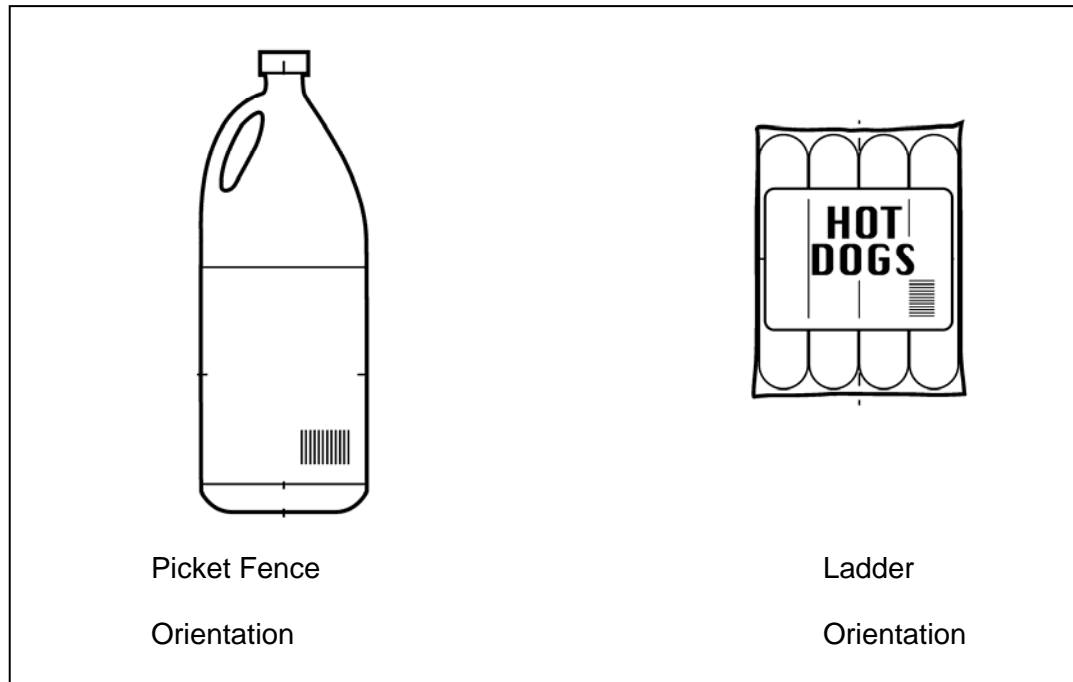

Figure 2.1 – Examples of picket fence and ladder orientation

### 2.3.1 Printing Direction

Bar code orientation is often determined by the printing process. Some printing processes provide much higher quality results if the bars of the symbol run in the direction of print, also known as the web direction. Always consult the printing company.

### 2.3.2 Trade Items with Curved Surfaces

When a bar code symbol is printed onto a curved surface, it is sometimes possible for the extremes of the symbol to disappear around the curve, so that both ends cannot be visible to the scanner at the same time. This is more likely to occur the bigger the symbol and the tighter the curve of the packaging. There are certain combinations of X-dimension and diameter of curved surface in which the bars must be printed around the curve (e.g., in ladder orientation on a can, in picket fence orientation on a cylindrical packet of biscuits). The effect of this is to ensure that the curve results in an apparent loss of height of the bars rather than the more serious apparent loss of complete bars.

The angle between the tangent to the center of the curved symbol and the tangent to the extremity of the curved symbol (outer edge of the guard bars for symbols in the EAN/UPC symbology family) must be less than 30 degrees. If this angle is more than 30 degrees, orient the symbol such that the bars are perpendicular to the generating lines of the surface of the item. See *Appendix A* for more information.

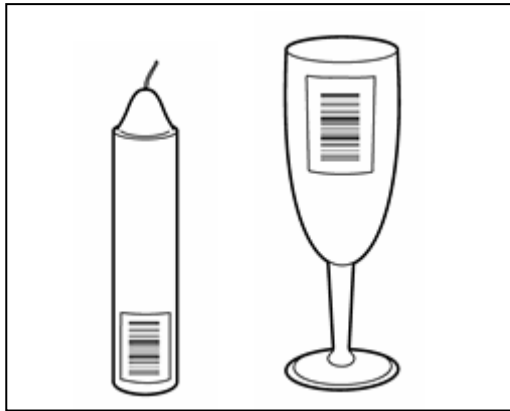

Figure 2.2 – Bar codes in ladder orientation are recommended for curved surfaces with a small radius

### 2.3.3 Avoiding Scanning Obstacles

Anything that will obscure or damage a bar code symbol will reduce scanning performance and should be avoided. For example:

- Never position the bar code symbol on the item in an area with inadequate space. Do not let the other graphics encroach on the space for the bar code.
- Never place bar code symbols, including Quiet Zones, on perforations, die-cuts, seams, ridges, edges, tight curves, folds, flaps, overlaps, and rough textures.
- Never put staples through a bar code symbol or its Quiet Zones.
- Never fold a symbol around a corner.
- Never place a symbol under a package flap.



### **3 General Placement Guidelines for Point-of-Sale**

This section outlines the guidelines for bar code symbol placement on trade items that will be scanned at the point-of-sale (POS). For detailed information on specific package types, see *Sections 4 and 5*. *Section 7* outlines the guidelines for bar code symbol placement on trade items that will be scanned in warehousing or General Distribution Scanning environments.

#### **3.1 Number of Symbols**

Only one bar code symbol should be visible on a trade item intended for the POS. Exceptions include large or bulky items see (*Section 4.9*) and random or unregistered wrapping (see *Section 3.3.6*).

Trade items should never have more than one bar code symbol carrying a single Global Trade Item Number (GTIN) visible. At the POS, this is particularly relevant to multipacks, such as over-wrapped items, sleeved items, and banded items, where the individual inner units carry a different GTIN from that on the outer wrapper or container. The bar code symbols on the inner products must be totally obscured so that they cannot be read by the POS system. (See *Section 3.3.6* for over-wrap special considerations.)

#### **3.2 Identifying the Back of the Trade Item**

The front of the trade item is the primary trading / advertising area, which typically displays the product name and the company's logo. The back of the trade item is directly opposite the front and is the preferred placement area for the bar code symbol on most trade items.

#### **3.3 Symbol Placement**

Information in this section is provided to guide symbol placement when developing packaging for new products and should be adopted if economically feasible when changing the graphics of existing products.

##### **3.3.1 Preferred Placement**

Preferred bar code symbol placement is on the lower-right quadrant of the back, respecting the proper Quiet Zone areas around the bar code symbol and the edge rule (see *Section 3.3.3* and special considerations in *Section 3.3.7*).

##### **3.3.2 Undesirable Alternative**

The undesirable alternative placement for a bar code symbol is the lower-right quadrant of another side of the container.

##### **3.3.3 Edge Rule**

The bar code symbol must not be closer than 8 mm (0.3 inches) or farther than 102 mm (4 inches) from any edge of the package / container. Previous guidelines suggested a distance of 5 mm (0.2 inches) as a minimum. Practical experience has shown this to be inadequate. For example, cashiers often grab bags and other trade items on the edge with their thumbs. Avoid

placing the bar code symbol too close to the edge. Such placement reduces efficiency at the POS.

### 3.3.4 Avoid Truncated Symbols

Truncation of a bar code symbol is the reduction of the height of a bar code symbol relative to its length. Truncation is not recommended because it destroys the ability of a symbol to be scanned omnidirectionally at the POS. A truncated symbol can only be scanned when the trade item is oriented in particular directions across the scanning beam. Truncation, therefore, reduces checkout efficiency. The more the height of the symbol is reduced, the more critical becomes the alignment of the symbol across the scanning beam. Avoid truncation unless absolutely necessary and then print the maximum height possible. See *Appendix A* for the relationship between the diameter and X-dimension.

### 3.3.5 Bottom Marking

Bottom marking of the trade item with the bar code symbol continues to be acceptable, except for large, heavy, or bulky trade items. However, back (side) marking is preferred.

### 3.3.6 Exceptions to the General Placement Guidelines

Some trade items require special considerations for bar code symbol placement.

- Bags – Settling of the contents usually results in bag edges bulging to the extent that bar code symbols located on the lower-right quadrant may not be flat enough to permit successful scanning. For this reason, bar code symbols on bags should be placed in the center of the back about one third up from the bottom and as far from the edge as possible while respecting the edge rule. See *Section 4.1* for more details on bags.
- Blister packs or unpackaged items – Trade items that cause scanners to read beyond the flat plane include blister packs and unpackaged items (e.g., deep bowls). For these package types, the distance between the scanner window and the bar code symbol on the container or item must be considered. The bar code symbol cannot be closer than 8 mm (0.3 inches) or farther than 102 mm (4 inches) from any edge of the package / container. See *Section 4.2* for more details on blister packs and unpackaged items.
- Large, heavy, or bulky items – Any package / container weighing more than 13 kg (28 lb.) or having two dimensions greater than 45 cm (18 inches) (width / height, width / depth, or height / depth) is considered a large, heavy, or bulky item. Large, heavy, or bulky items tend to be hard to handle. Large bags require two symbols, one on top and one on the bottom of opposite quadrants of the bag. Large, heavy, or bulky bottles, boxes, cans, jars, jugs, and tubs require only one label. See *Section 4.9* for more details on large, heavy, or bulky items.
- Thin items or containers – Thin items or containers are packages / containers with a dimension less than 3 cm (1 inches) (height, width, or depth). Examples of thin items or containers are packages of pizza, powdered drink mixes, and writing pads. Any placement of the symbol on the edge hinders effective scanning because the symbol is obscured from the cashier and is likely to be truncated. Refer to *Section 4.12* for more details on thin items or containers.

### 3.3.7 Special Packaging Considerations for Bar Code Placement

Specific packaging methods require special considerations for bar code symbol placement.

- Over-wrap – Trade items to be sold in multiples are mechanically gathered and covered with clear over-wrap material that will carry print. Typical over-wrapped items are small cereal boxes and chocolate bars. Package over-wrap can create two distinct problems:
  - Obscuring the bar code symbols on individual units inside the multi-pack is necessary so they are not confused with the outer multi-pack bar code symbol, which must be different.
  - Over-wrapping with such materials as cellophane causes diffraction or reflection of the light beam of the scanner and can reduce contrast, which causes scanning inefficiencies.

To determine proper bar code symbol placement for over-wrapped packaging, follow the guidelines specific to the applicable package type / shape. Refer to *Section 4* for details on symbol placement for specific package types.

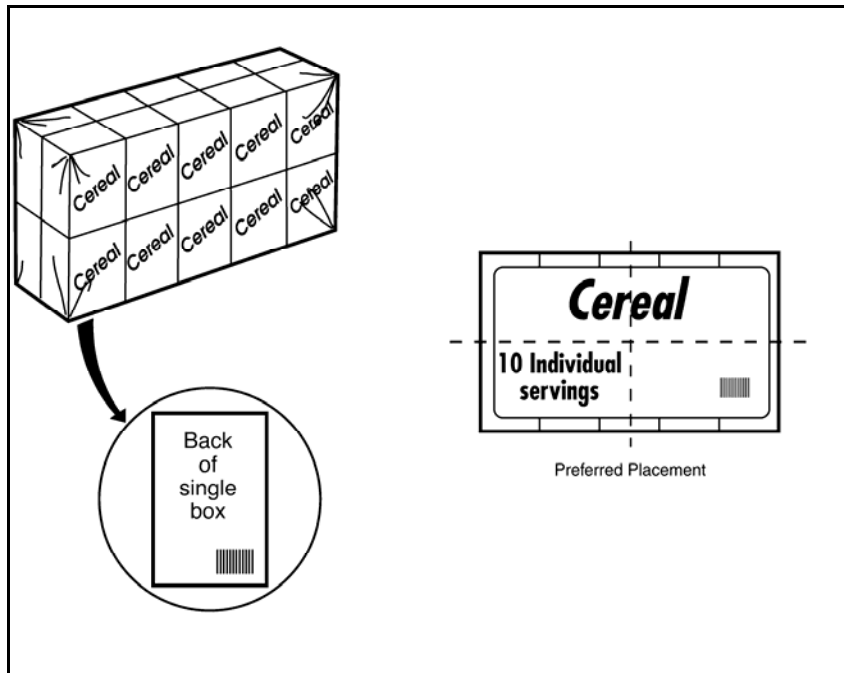

Figure 3.1 – Bar code symbol placement on over-wrapped item

- Random (unregistered) wrap

Some wrappers, like those used on sandpaper or margarine, have a repeating design and are neither cut nor placed on the product such that a particular part of the design always appears in the same location. This is referred to as random or unregistered wrapping. As the wrapper is not registered, it is unlikely that the symbol will appear on one face of the package when the wrapper is placed on the product.

Experience has shown that the presence of more than one bar code symbol on a package can have a detrimental effect on scanning productivity and, more importantly, can lead to a double read. For this reason, the use of registered packaging is preferred.

If random wrap must be used, the minimum requirement is to print the symbol with sufficient frequency that a full symbol will appear on one package face.

Double reads are more likely when the gaps between the symbols are larger. Repeating symbols should never be more than 150 mm (6 inches) apart.

Consideration should also be given to elongating the bars of the symbol to ensure a full symbol on one face, instead of repeating the symbol.

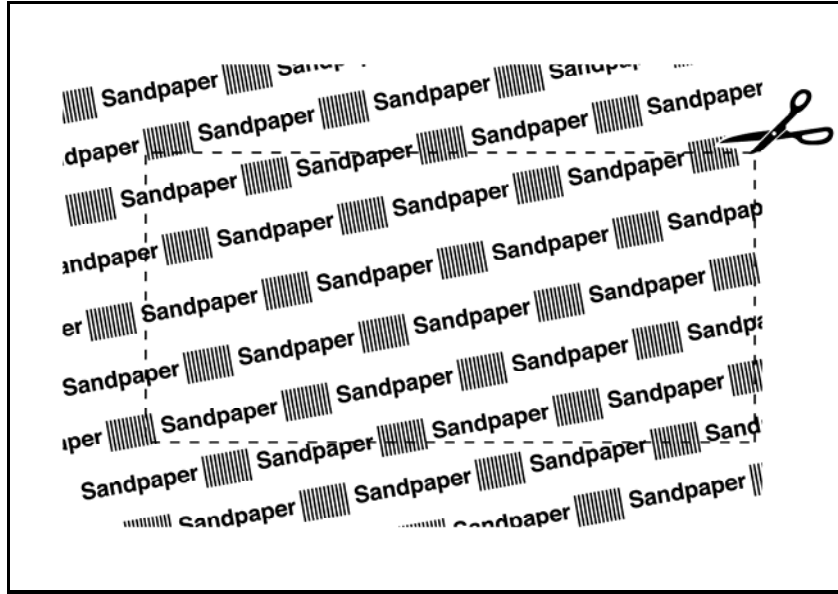

Figure 3.2 – Bar code symbol placement on random-wrapped item

- Shrink film / vacuum-formed packages

The bar code symbol on an item packaged in shrink film or that is vacuum-formed should be located on a flat surface and in an area free of creases, wrinkles, or other types of distortions. Refer to the following figure, which shows bar code symbol placement on hot dogs. Since the curvature of the hot dogs was greater than the diameter shown within *Appendix A* figures, a ladder orientation bar code symbol was selected.

To determine proper bar code symbol placement for shrink film / vacuum-formed packaging, follow the guidelines specific to the applicable package type / shape. Refer to *Section 4* for details on symbol placement for specific package types / shapes.

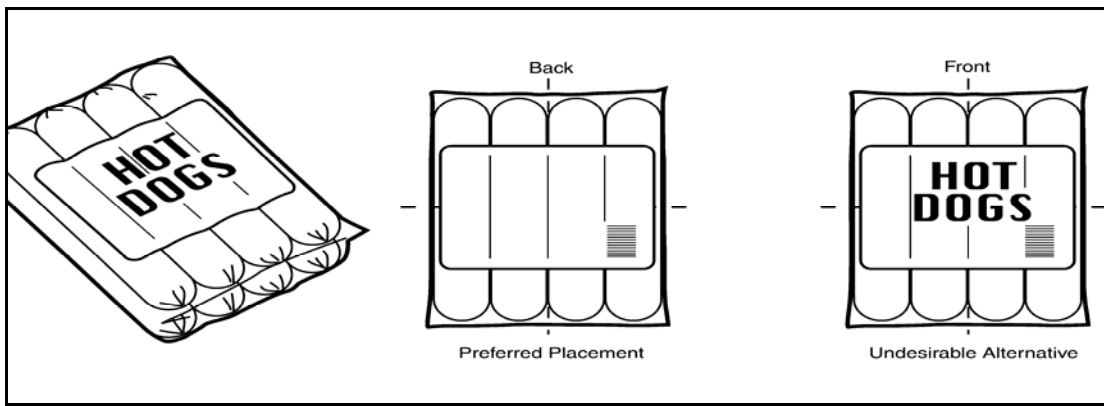

Figure 3.3 – Bar code symbol placement on shrink film / vacuum-formed item

- Spot labels

Bar code symbols printed on spot labels that are applied to the trade item are acceptable alternatives that incorporate symbols into existing packaging graphics or for use on items without packages, such as some pots, pans, tableware and glassware. The most suitable type of spot labels are those that cannot be removed from the item without destroying the symbol. Labels that are applied directly to the product should use an adhesive that is strong enough to adhere to the label for an extended shelf life, but which also allows the label to be removed without the use of solvents or abrasives.

To determine proper bar code symbol placement on items bearing spot bar code symbol labels, follow the guidelines specific to the applicable package type / shape. Refer to *Section 4* for details on symbol placement for specific package types.

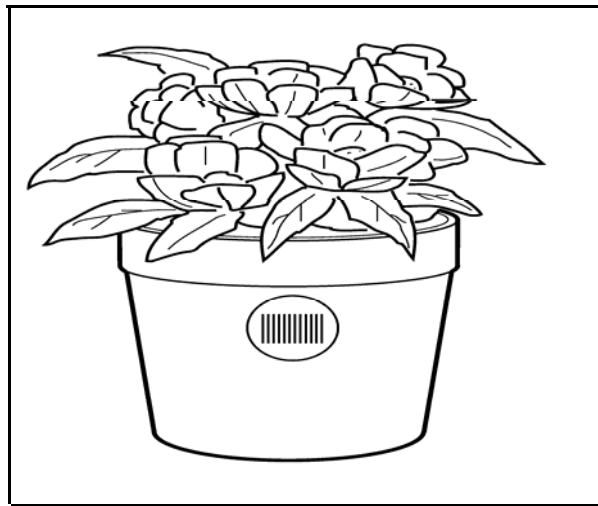

Figure 3.4 – Bar code symbol placement with a spot label

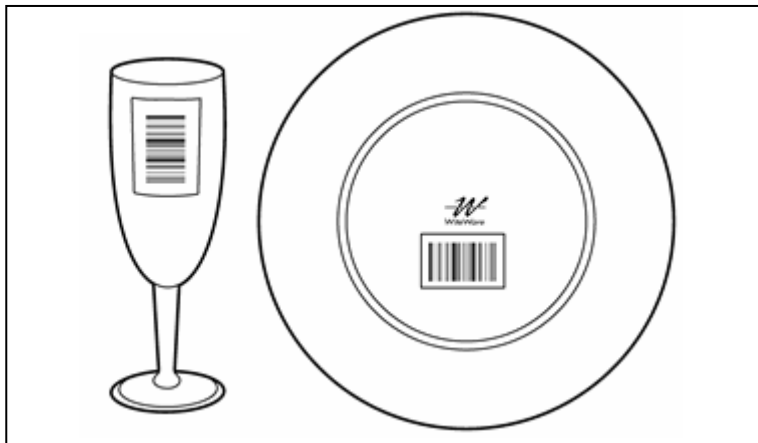

Figure 3.5 – Tableware items using bar code spot labels. The adhesive used should not damage the item.

### 3.3.8 Operational Considerations of Bar Code Placement

Speed, efficiency, and effectiveness in scanning operations are the ultimate goals of proper bar code symbol placement. To ensure that scanning performance is not compromised, consider the following matters before deciding on final bar code symbol placement:

- Consistent symbol location – Compare your package / container to packaging for like products to ensure equivalent symbol placement. The ease with which bar code symbols are located by a cashier from product to product essentially relies on consistent symbol placement.
- Hand motion effectiveness – Pass the bar code symbol across the scanner with your hand to test the initial bar code symbol placement. This test is intended to confirm that the bar code symbol placement does not necessitate unnatural hand motions while you are scanning the symbol.

### 3.3.9 Security Tag Placement

When a security tag is used, which is intended to be visible, the preferred placement is within a 75mm (3 inches) diameter of the bar code symbol placement. Consistent security tag placement makes it easier for the operator to predict where the security tag is located and thus improves efficiency.

## 4 Placement Guidelines for Specific Package Types

The following bar code symbol placement guidelines apply to specific package types. *Section 5* contains diagrams illustrating symbol placement for clothing and fashion accessories. The following table describes the main packaging categories and products. This table can be used to determine correct bar code symbol placement by product or packaging. For example, according to the table, a package of flower seeds in a 5.1 cm (2 inches) by 7.6 cm (3 inches) envelope is classified as a thin item or container. The example given of this type of package is powdered soft drink mix. According to the first column of the package type reference, the correct bar code symbol placement for this package type can be determined by looking at *Section 4.12*.

Section	Package Type	Package Characteristics	Product Examples
4.1	Bags	Sealed cylindrical or rounded-corner wrapped units	Potato chips, flour, sugar, bird seed
4.2	Blister packs	Flat card backing a formed clear plastic bubble placed over product	Toys, hardware parts
4.3	Bottles and jars	Small or large-mouth vessels sealed with removable lids	Barbecue sauce, fruit jelly
4.4	Boxes	Folded, sealed heavy paper or corrugated cardboard cartons	Crackers, cereal, detergent
4.5	Cans and cylinders	Cylindrical-shaped units sealed at each end	Soups, drinks, cheese, biscuits
4.6	Carded items	Items mounted or sealed on flat cards	Hammers, parcels of candy, kitchen utensils
4.7	Egg cartons	Irregular hexahedrons of plastic or molded pulp with hinged lids	Eggs
4.8	Jugs	Glass or plastic vessel with built-in handle(s) and removable lid(s)	Household cleaners, cooking oil
4.9	Large, heavy, bulky items	Items having physical dimension of 45 cm (18 in.) or more in any two dimensions and / or weight in excess of 13 kg (28 lbs.)	Pet food, unassembled furniture, sledge hammers
4.10	Multi-packs	Multiple items mechanically bound to create one package	Soft drink cans
4.11	Publishing items	Printed paper media that is bound, stapled, or folded	Books, magazines, newspapers, tabloids
4.12	Thin items or containers	Items or containers with one dimension less than 3 cm (1 inch)	Boxes of pizza, CD jewel boxes, powdered soft drink mix packages, writing pads

Section	Package Type	Package Characteristics	Product Examples
4.13	Trays	Flat, formed receptacles holding product covered with over-wrap	Prepared meats, pastries, snacks, pies, pie crusts
4.14	Tubes	Firmly packed cylinders sealed at both ends, or sealed at one end with a cap or valve on the other end	Toothpaste, sausage, caulk
4.15	Tubs	Deep vessels with removable lids	Margarine, butter, ice cream, whipped cream
4.16	Unpackaged	Trade items that have no packaging, are often of an unusual shape, and are hard to label and scan	Frying pans, mixing bowls, cooking pots, and giftware
4.17	Sets	Trade items that can be sold individually or as part of a boxed set	Table and giftware
4.18	Sporting Goods	Unpackaged items of specific size and shape	Racquets, skis, and skateboards
4.19	Rough or textured surfaces	Some merchandise may not allow for application of bar code labels due to rough or textured surfaces	Powder coated surfaces and cast iron

Figure 4.1 – Package type reference

## 4.1 Bags

Although this category is referred to as “bags,” these packages / containers are often called sacks or pouches. This category includes paper or plastic containers that are:

- Fold-sealed on both ends (e.g., flour and sugar)
- Fold-sealed on one end and pinched sealed at the other end (e.g., potato chips)
- Pinch-sealed at both ends (e.g., cough drops)
- Fold-sealed on one end and gathered at the other end (e.g., bread)

**NOTE:** Some bags are sealed at both ends and carded for display, such as bags of sweets. These types of items are not considered bags but fall into the carded items category. See *Section 4.6* for more details on carded items.

- Package characteristics: Sealed cylindrical or rounded-corner wrapped units
- Unique considerations: Bags have a tendency to have contents that shift and bulge. Consequently, the bar code symbol placement must be on an area of the bag that is most likely to remain flat.
- Bar code symbol placement: Identify the front of the package / container. Refer to *Section 3.2*, for instructions on how to identify the package front.



- Preferred placement: On the lower-right quadrant of the back and away from the edge, respecting the proper Quiet Zone areas around the bar code symbol.
- Undesirable alternative: On the lower-right quadrant of the front, and away from the edge, respecting the proper Quiet Zone areas around the bar code symbol.
- Edge rule: The bar code symbol cannot be closer than 8 mm (0.3 inches) or farther than 102 mm (4 inches) from any edge of the package / container.

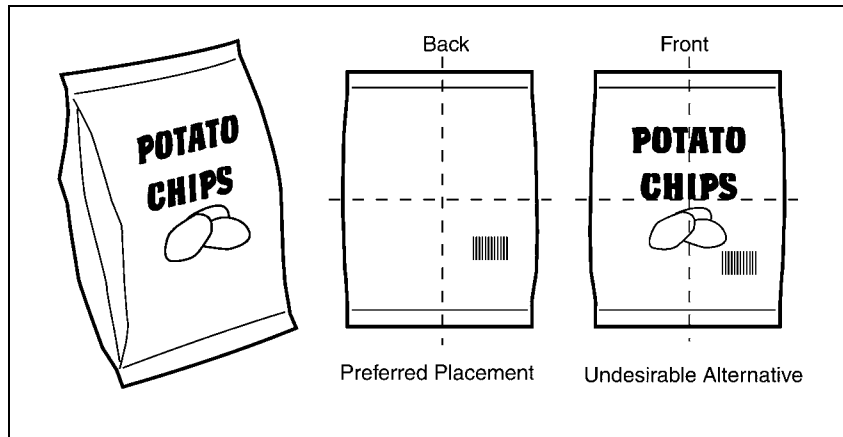

Figure 4.2 – Symbol placement on bags

## 4.2 Blister Packs

Blister packs are pre-formed clear plastic bubbles, or blisters, containing a product and backed or topped with cardboard stock.

- Package characteristics: Flat card, backing a formed clear plastic bubble placed over the product.
- Unique considerations: To ensure quality scanning, the bar code symbol must be clear of the edges of the blister. Avoid placing the symbol under the blister pack or placing the symbol over any perforations on the back of the package.
- Bar code symbol placement: Identify the front of the package / container. Refer to *Section 3.2*, for instructions on how to identify the package front.
  - Preferred placement: On the lower-right quadrant of the back, near the edge, respecting the proper Quiet Zone areas around the bar code symbol.
  - Undesirable alternative: On the lower-right quadrant of the front, near the edge, respecting the proper Quiet Zone areas around the bar code symbol.
- Edge rule: The bar code symbol cannot be closer than 8 mm (0.3 inches) or farther than 102 mm (4 inches) from any edge of the package / container.

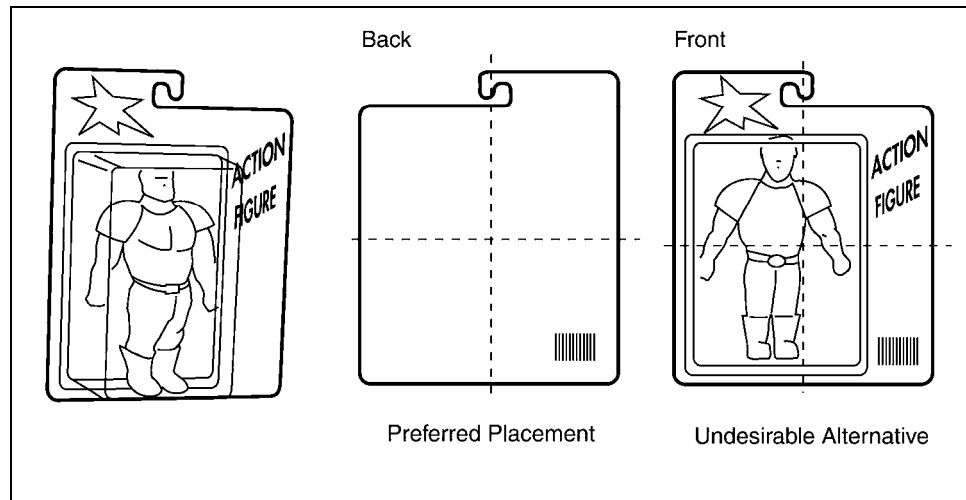

Figure 4.3 – Symbol placement on blister packs

### 4.3 Bottles and Jars

Bottles and jars typically carry spot labels applied to confined areas of the package, not covering the entire surface or wrapping around the entire perimeter.

- Package characteristics: Small or large-mouth containers sealed with removable lids.
- Unique considerations: Application of the bar code symbol to the neck of a bottle is not allowed. Symbol placement on the neck of the bottle necessitates additional handling at the POS, and space limitations on this area of the bottle usually result in symbol truncation.
- See *Appendix A* for rules on the relationship between the diameter of the item and the bar code symbol X-dimension.
- Bar code symbol placement: Identify the front of the package / container. Refer to *Section 3.2* for instructions on how to identify the package front.
  - Preferred placement: On the lower-right quadrant of the back, near the edge, respecting the proper Quiet Zone areas around the bar code symbol.
  - Undesirable alternative: On the lower-right quadrant of the front, near the edge, respecting the proper Quiet Zone areas around the bar code symbol.
  - Edge rule: The bar code symbol cannot be closer than 8 mm (0.3 inches) or farther than 102 mm (4 inches) from any edge of the package / container.

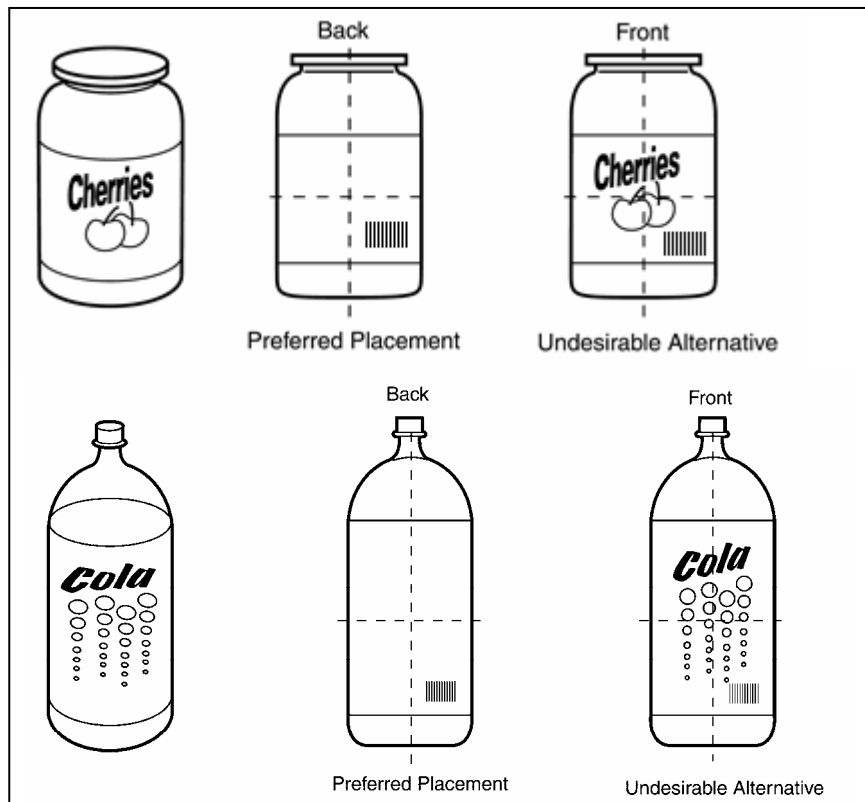

Figure 4.4 – Symbol placement on bottles and jars

#### 4.4 Boxes

This package type includes cuboid or cylindrical cardboard or plastic cartons, as well as rectangular sleeves (used for products such as light bulbs). These packages might contain anything from crackers or cereal to detergent.

- Package characteristics: Folded, sealed heavy paper or corrugated cardboard cartons.
- Unique considerations: There are no unique considerations that apply to this package type.
- Bar code symbol placement: Identify the front of the package / container. Refer to *Section 3.2* for instructions on how to identify the package front.
  - Preferred placement: On the lower-right quadrant of the back, near the edge, respecting the proper Quiet Zone areas around the bar code symbol.
  - Undesirable alternative: On the lower-right quadrant of the front, near the edge, respecting the proper Quiet Zone areas around the bar code symbol.
- Edge rule: The bar code symbol cannot be closer than 8 mm (0.3 inches) or farther than 102 mm (4 inches) from any edge of the package / container.

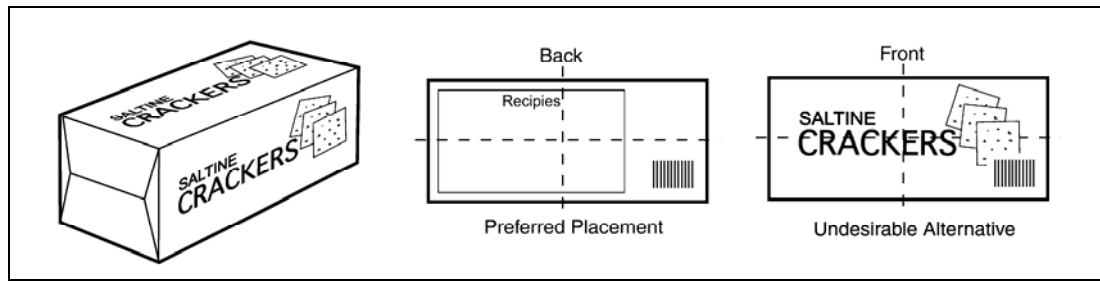

Figure 4.5 – Symbol placement on boxes

## 4.5 Cans and Cylinders

This category includes cylindrical shaped containers (usually made of plastic or metal) that are sealed at each end. Some containers have removable lids or openings. Common examples include canned fruit and vegetables, paints, and adhesives.

- Package characteristics: Cylindrical-shaped units sealed at each end.
- Unique considerations: Obstacles, such as beading, seams, and / or ridges on the package / container should be avoided, as they will reduce scanning performance.
- See *Appendix A* for rules on the relationship between the diameter of the item and the X-dimension.
- Bar code symbol placement: Identify the front of the package / container. Refer to *Section 3.2* for instructions on how to identify the package front.
  - Preferred placement: On the lower-right quadrant of the back, near the edge, respecting the proper Quiet Zone areas around the bar code symbol.
  - Undesirable alternative: On the lower-right quadrant of the front, near the edge, respecting the proper Quiet Zone areas around the bar code symbol.
- Edge rule: The bar code symbol cannot be closer than 8 mm (0.3 inches) or farther than 102 mm (4 inches) from any edge of the package / container.

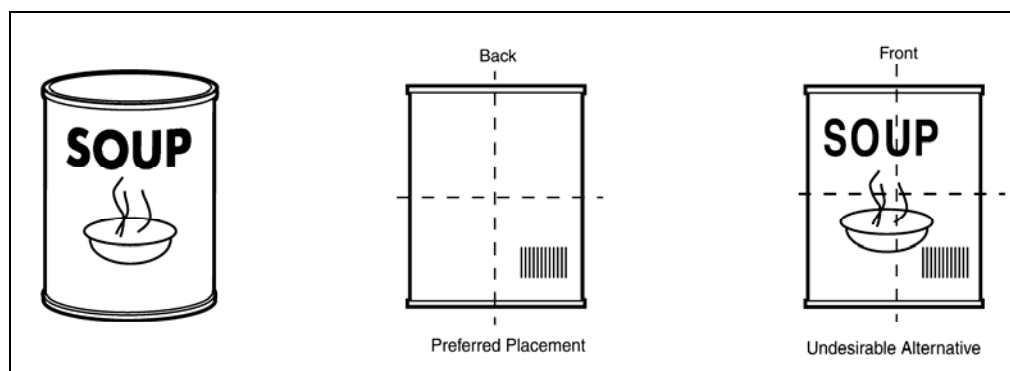

Figure 4.6 – Symbol placement on cans and cylinders

## 4.6 Carded Items

Small, loose, or non-packaged items that are difficult to label are placed on cards that are marked with a bar code symbol. Examples include hammers, toys, and kitchen utensils.

- Package characteristics: Items mounted or sealed on flat cards.
- Unique considerations: When placing bar code symbols on carded items, it is important to take into consideration the proximity of the bar code symbol to the product. Be sure to allow adequate space for the symbol, avoiding any obstructions that might be caused by placing the symbol too close to the product. In addition, do not place the symbol over any perforations or other obstructions on the package.
- Bar code symbol placement: Identify the front of the package / container. Refer to *Section 3.2* for instructions on how to identify the package front.
  - Preferred placement: On the lower-right quadrant of the back, near the edge, respecting the proper Quiet Zone areas around the bar code symbol
  - Undesirable alternative: On the lower-right quadrant of the front, near the edge, respecting the proper Quiet Zone areas around the bar code symbol
- Edge rule: The bar code symbol cannot be closer than 8 mm (0.3 inches) or farther than 102 mm (4 inches) from any edge of the package / container.

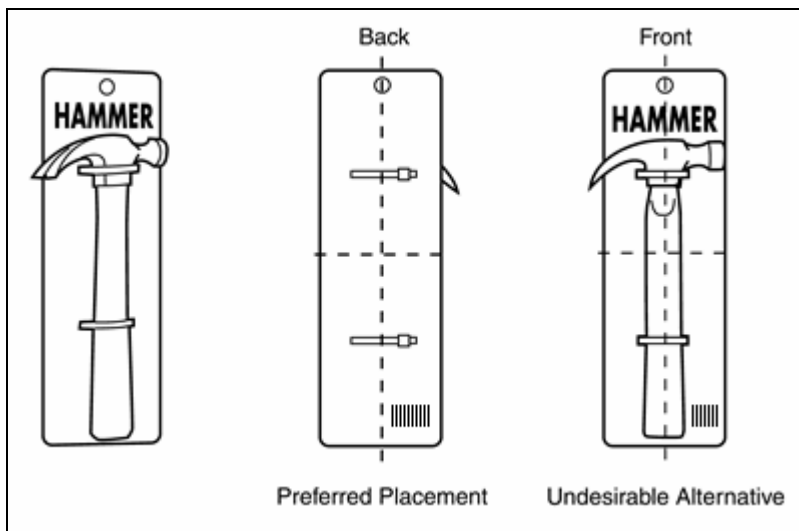

Figure 4.7 – Symbol placement on carded items

## 4.7 Egg Cartons

Molded pulp, foam, or plastic egg cartons come in sizes according to the count of the eggs contained.

- Package characteristics: Irregular shaped hexahedrons of plastic or molded pulp with a hinged lid.
- Unique considerations: The recommended symbol placement is on the side of the lid portion of the egg carton that opens and closes to cover the eggs. The

uneven surface of the molded bottom of an egg carton prevents bar code symbol placement in this area.

- Bar code symbol placement: To determine bar code symbol placement on an egg carton, first identify the top of the carton by locating the primary trading / advertising area, which is marked with the product name and the company's logo. The bottom of the egg carton is the molded area directly opposite the top in which the eggs sit. The sides are divided horizontally by a hinged lid. The front of the carton is the long side containing the opening/closing mechanism. The back of the carton is directly opposite the front, on the long side with the hinge.
- Preferred placement: Near the edge, on the right half of the back, above the hinge on the lid, respecting the proper Quiet Zone areas around the bar code symbol.
- Undesirable alternative: On the lower-right quadrant of the top, on the lid adjacent to the opening/closing mechanism, near the edge, respecting the proper Quiet Zone areas around the bar code symbol.
- Edge rule: The bar code symbol cannot be closer than 8 mm (0.3 inches) or farther than 102 mm (4 inches) from any edge of the package / container.

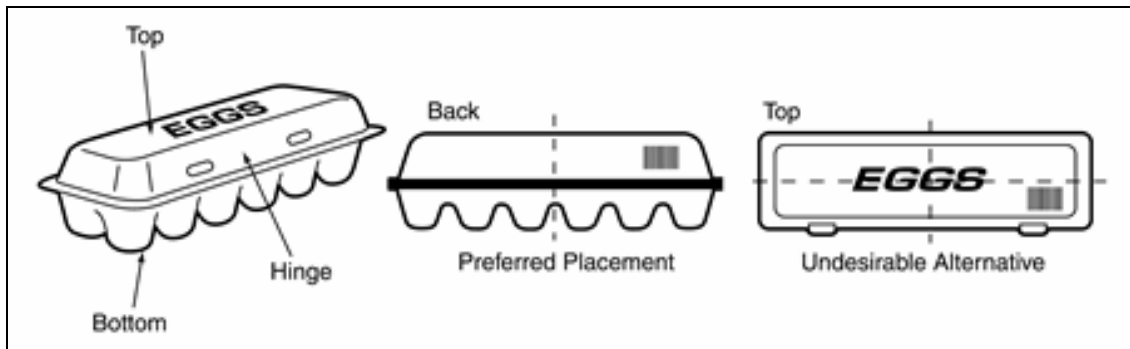

Figure 4.8 – Symbol placement on egg cartons

## 4.8 Jugs

Jugs are glass or plastic containers with built-in handle(s) that aid in pouring of contents. Jugs typically carry spot labels applied to defined areas of the package, not covering the entire surface of the trade item or wrapping around the entire perimeter of the item.

- Package characteristics: Glass or plastic vessels with built-in handles and removable lids.
- Unique considerations: Application of the symbol to the neck of the jug is not allowed. Placement of the symbol on the neck of the jug necessitates additional handling at the POS, and space limitations on the neck usually result in symbol truncation.
- See *Appendix A* for rules on the relationship between the diameter of the item and the X-dimension.
- Bar code symbol placement: Identify the front of the package / container. Refer to *Section 3.2* for instructions on how to identify the package front.

- Preferred placement: On the lower right quadrant of the back, near the edge, respecting the proper Quiet Zone areas around the bar code symbol
- Undesirable alternative: On the lower right quadrant of the front, near the edge, respecting the proper Quiet Zone areas around the bar code symbol.
- Edge rule: The bar code symbol cannot be closer than 8 mm (0.3 inches) or farther than 102 mm (4 inches) from any edge of the package / container.

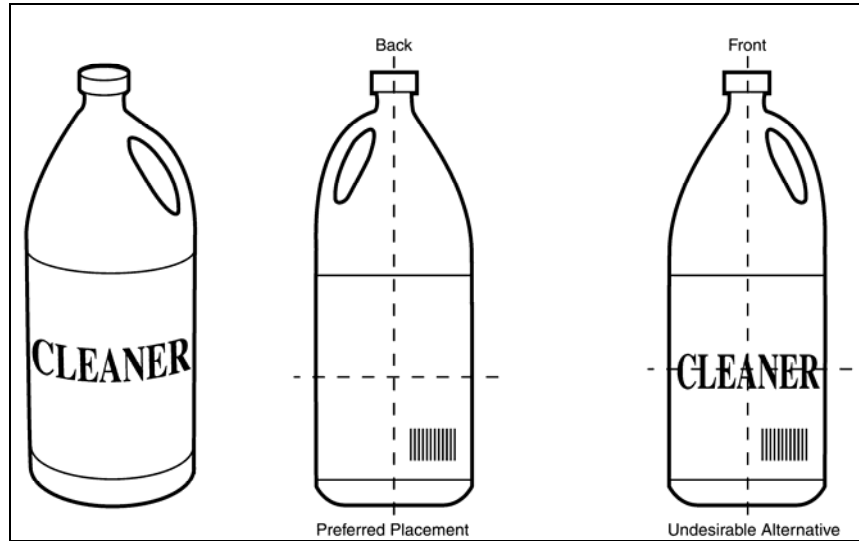

Figure 4.9 – Symbol placement on jugs

#### 4.9 Large, Heavy, or Bulky Items

Large, heavy, or bulky items of any kind are difficult to handle and scan, and, therefore, different symbol placement guidelines apply.

- Package characteristics: Items considered large, heavy, or bulky have a physical dimension of 45 cm (18 inches) or more in any two dimensions (width / height, width / depth, or height / depth), and / or weigh in excess of 13 kg (28 lbs.).
- Unique considerations:
  - Number of symbols: For large or heavy bags, use two bar code symbols, one on top of the front and one on the bottom of the back in opposite quadrants. For boxes, bottles, jars, cans, jugs, tubs, and unpackaged items, use one bar code symbol.
  - Special labels: A special double label with a tear-out bar code symbol may be applied to large, heavy, or bulky items that are too heavy or too awkward to pick up and pass over a fixed scanner. This label has one section that is permanently adhered to the item's box (or to a hang-tag or card if the item is not boxed). This section has a Human Readable Interpretation number and item description printed above a full-size bar code symbol. Beneath a perforation, a second section contains exactly the same human readable information and an identical full-size bar code symbol. The two sections are

virtually identical except that the section below the perforation has no adhesive on its back.

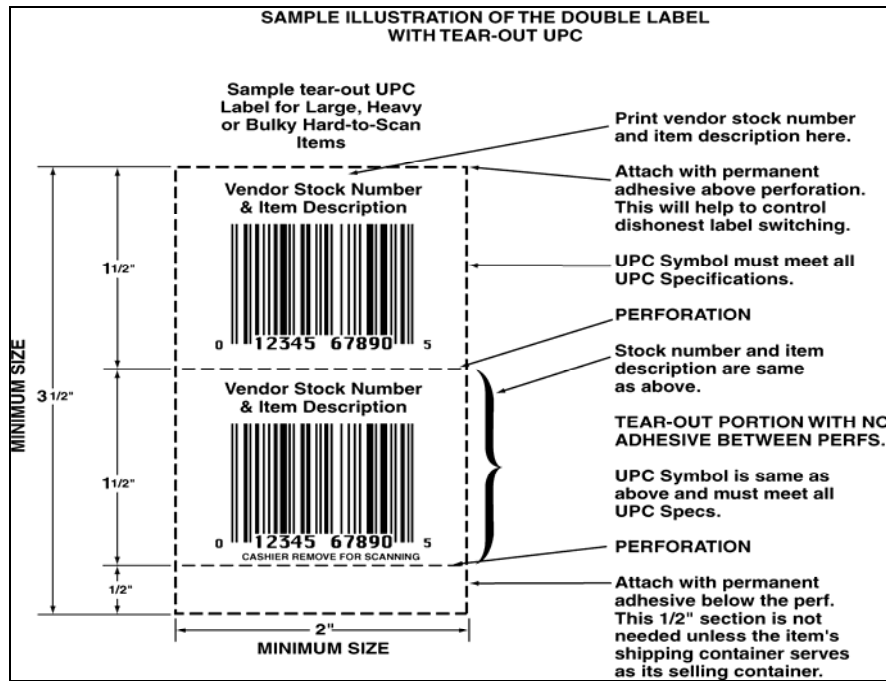

Figure 4.10 – Example of a double label

When the item is brought to the POS, the lower half of the label below the perforation is removed. The cashier then either scans the label, or if the symbol cannot be scanned, the cashier key-enters the human readable information beneath the symbol. The top label remains attached to the item or its box.

In the instances where the large, heavy, or bulky item is displayed and sold in its shipping container, a third section of label is recommended. Beneath the tear-out label, add a second perforation and a 12 mm (0.50 inches) section with permanent adhesive. This provides a more secure vehicle for the tear-out section and makes it less likely to tear off in transit.

Human Readable Interpretation: Human readable numbers or text on large, heavy, or bulky items should be a minimum of 16 mm (5/8 inches) high. This facilitates easier capture of the number by the cashier without having to pick up the product and move it across the scanner.



### 4.9.1 Bar Code Symbol Placement

Identify the front of the package / container. See *Section 3.2* for instructions on how to identify the package front.

- Preferred placement:
  - Bags: Two bar code symbols are required, one on the front of the bag, at the top of the upper-right quadrant, near the edge, and the other on the back of the bag, centered in the lower-right quadrant, near the edge (to accommodate settling of contents).

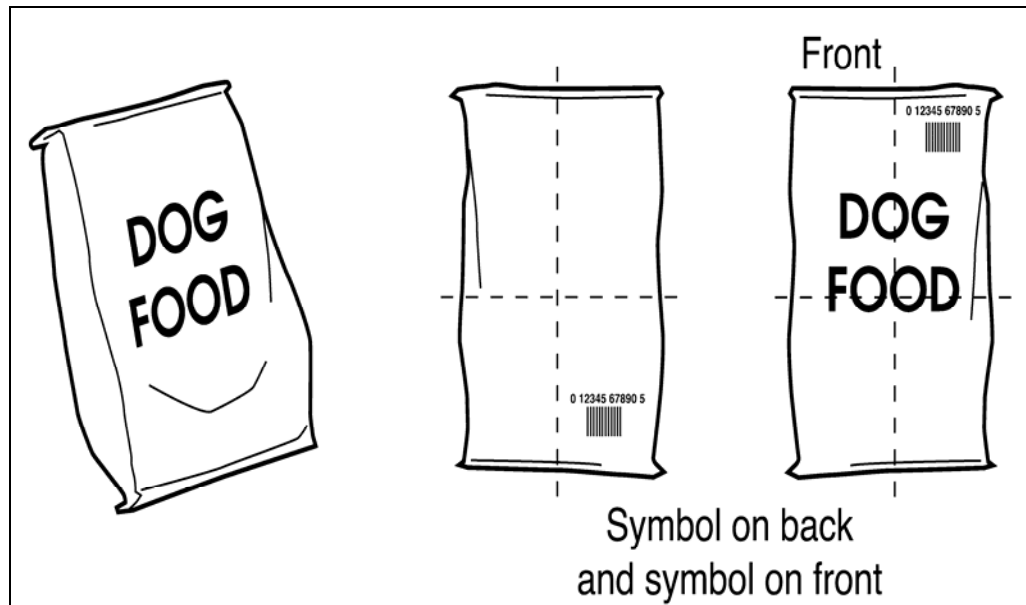

Figure 4.11 – Symbol placement on large, heavy, or bulky bags

- Bottles, jars, boxes, cans, jugs, tubs, and unpackaged items: These items are subject to the same symbol placement guidelines as corresponding smaller sized items. Refer to the appropriate subsection in *Section 4* for symbol placement guidelines for specific package types.

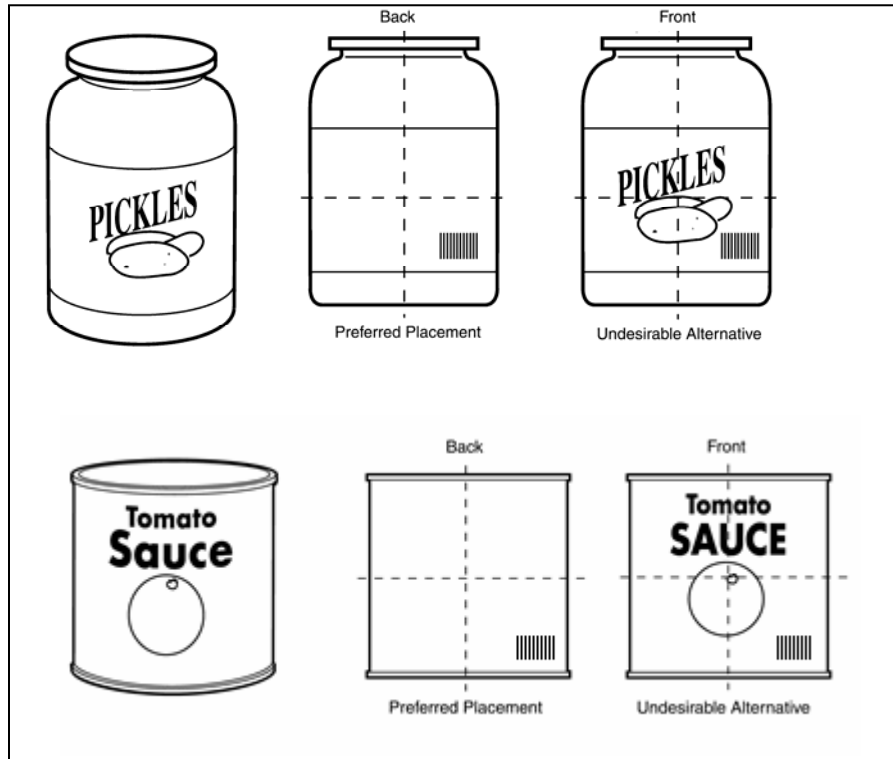

Figure 4.12 – Symbol placement on large, heavy, or bulky jars, cans, jugs, or tubs

- Undesirable alternative: On the lower-right quadrant of the front, near the edge, respecting the proper Quiet Zone areas around the bar code symbol
- Edge rule: The bar code symbol cannot be closer than 8 mm (0.3 inches) or farther than 102 mm (4 inches) from any edge of the package / container.

#### 4.10 Multi-packs

Multi-packs are single items that are packaged together as one unit or trade item. Multi-packs provide convenience to the consumer and / or may represent a price reduction compared to purchasing items individually. Typical multi-packs contain bottles, cans, jars, and tubs.

- Package characteristics: Multiple single items bound together to create one package.
- Unique considerations: As a general rule, place a bar code symbol on every consumer package traded through the supply chain. Consequently, items sold in multi-packs as well as those sold individually must carry a unique bar code symbol for each consumer package variation or aggregation. To avoid confusion at the POS, the multi-pack bar code symbol should be the only visible symbol when both the multi-pack and individual items are symbol-marked. The binder of the multi-pack acts as a screen to obscure the symbols on the individual items.
- Special note for can multi-packs: Avoid placing the symbol on the top or bottom of the container as shown in the following graphic, since the cans have a tendency to cause impressions in the cardboard and distort the symbol. These can impressions in the symbol may reduce the quality of the scanning.

- Bar code symbol placement: Identify the front of the package / container. Refer to *Section 3.2* for instructions on how to identify the package front.
  - Preferred placement: On the lower-right quadrant of the back, near the edge, respecting the proper Quiet Zone areas around the bar code symbol.
  - Undesirable alternative: On the lower-right quadrant of the side, near the edge, respecting the proper Quiet Zone areas around the bar code symbol.
  - Edge rule: The bar code symbol cannot be closer than 8 mm (0.3 inches) or farther than 102 mm (4 inches) from any edge of the package / container.

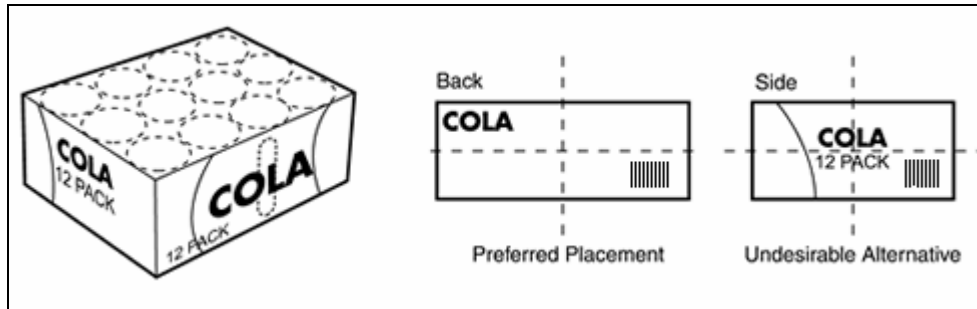

Figure 4.13 – Symbol placement on multi-packs

#### 4.11 Publishing Items

Publishing items represent printed materials sold individually for consumer use including books, magazines, newspapers, and tabloids. Bar code symbol placement on published items varies depending on type.

- Package characteristics: Printed paper media that is bound, stapled, or folded.
- Unique considerations: In addition to the regular bar code symbol, some publishing items have Add-On Symbols that carry supplementary information such as an Issue Code. Bar code symbol placement on published items varies depending on the media type. If an Add-On Symbol is used, it must be located to the right of the regular bar code symbol and parallel to it.

### 4.11.1 Bar Code Symbol Placement

Identify the front of the package / container. Refer to *Section 3.2* for instructions on how to identify the package front.

- Preferred placement:
  - Books: On the lower-right quadrant of the back, near the spine, respecting the proper Quiet Zone areas around the bar code symbol.

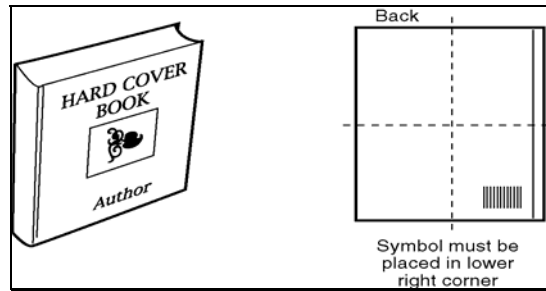

Figure 4.14 – Example of book bar code placement

- Magazines: On the lower-left quadrant of the front, near the edge, respecting the proper Quiet Zone areas around the bar code symbol.

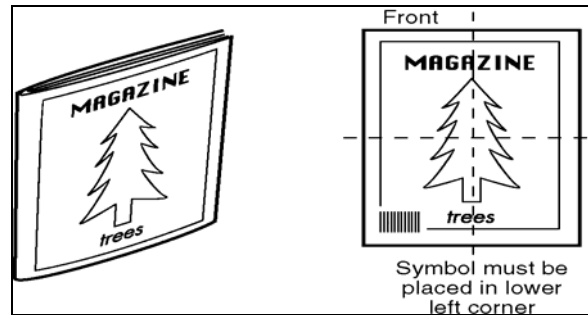

Figure 4.15 – Example of magazine bar code placement

- Newspapers: When displayed for sale as shown on the left in the following figure, place the symbol on the lower-left quadrant of the front, near the edge, respecting the proper Quiet Zone areas around the bar code symbol. If an Add-On Symbol is used, it must be located to the right of the regular bar code symbol and parallel to it.

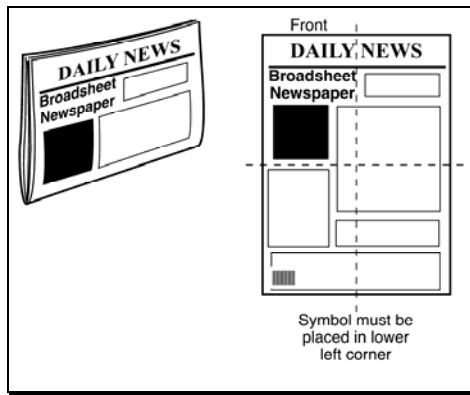

Figure 4.16 – Example of newspaper bar code placement

When displayed for sale as shown in the following figure, place the symbol on the lower-right quadrant of the back, near the edge, respecting the proper Quiet Zone areas around the bar code symbol. If an Add-On Symbol is used, it must be located to the right of the regular bar code symbol and parallel to it.

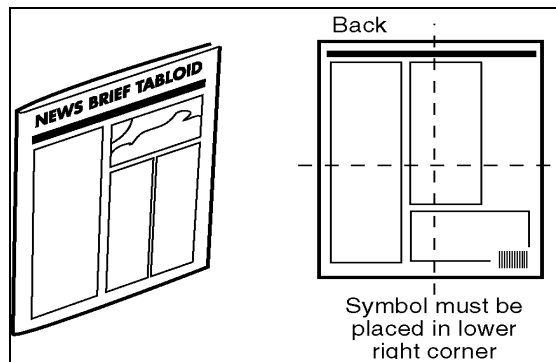

Figure 4.17 – Example of newspaper bar code placement

- Undesirable alternative: The undesirable alternative is not feasible for this package type.
- Edge rule: The bar code symbol cannot be closer than 8 mm (0.3 inches) or farther than 102 mm (4 inches) from any edge of the package / container.

## 4.12 Thin Items or Containers

This package type is so named as items or containers in this category have one physical dimension (height, width, or depth) less than 3 cm (1 inch). These items, particularly those without a significant bottom surface, should be marked on the lower-right quadrant of the back side. Examples include boxes of pizza, compact disk boxes, packages of powdered drink mix, and writing pads.

- Package characteristics: Items or containers with one dimension less than 3 cm (1 inch).
- Unique considerations: There are no unique considerations that apply to this package type.
- Bar code symbol placement: Identify the front of the package / container. Refer to *Section 3.2* for instructions on how to identify the package front.
- Preferred placement: On the lower-right quadrant of the back, near the edge, respecting the proper Quiet Zone areas around the bar code symbol.
- Undesirable alternative: On the lower-right quadrant of the front, near the edge, respecting the proper Quiet Zone areas around the bar code symbol.
- Edge rule: The bar code symbol cannot be closer than 8 mm (0.3 inches) or farther than 102 mm (4 inches) from any edge of the package / container.

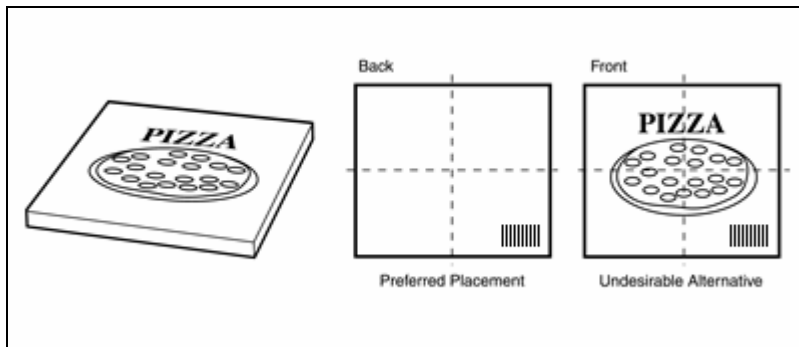

Figure 4.18 – Symbol placement on thin items or containers

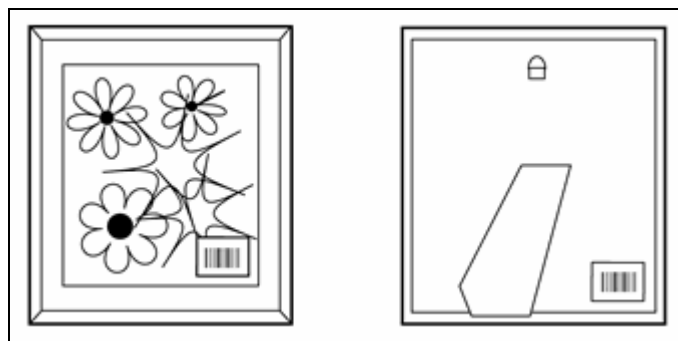

Figure 4.19 – Unpackaged item without room for bottom marking

## 4.13 Trays

This package type includes thin square, rectangular, or circular trays holding items that are covered with over-wrap of clear shrink-film or that are vacuum-sealed. Examples include prepared meats, pastries, snacks, and pies or piecrusts.

- Package characteristics: Flat, formed receptacles holding product covered with over-wrap.
- Unique considerations: When placing bar code symbols on trays, it is important to ensure that the bar code symbol is placed on a flat surface. In addition, do not place the symbol over any perforations or other obstructions on the package.
- Bar code symbol placement: Identify the front of the package / container. Refer to *Section 3.2* for instructions on how to identify the package front.
  - Preferred placement: On the lower-right corner of the top, near the edge, respecting the proper Quiet Zone areas around the bar code symbol.
  - Edge rule: The bar code symbol cannot be closer than 8 mm (0.3 inches) or farther than 102 mm (4 inches) from any edge of the package / container.

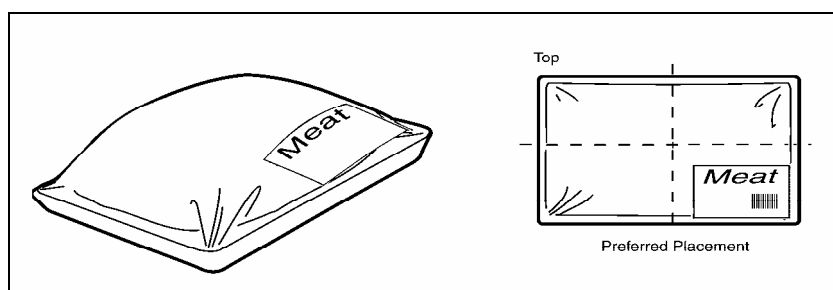

Figure 4.20 – Symbol placement on trays

## 4.14 Tubes

Tubes are cylindrical shaped items or containers that are either sealed at both ends, such as sausage or refrigerated dough, or that are sealed at one end and have a cap or valve on the other end, such as toothpaste or caulk.

- Package characteristics: Firmly packed cylinders sealed at both ends, or sealed at one end with a cap or valve on the other end.
- Unique considerations: See *Appendix A* for the rules on the relationship between the diameter of the item and the X-dimension.
- Bar code symbol placement: Identify the front of the package / container. Refer to *Section 3.2* for instructions on how to identify the package front.
  - Preferred placement: On the lower-right quadrant of the back, near the edge, respecting the proper Quiet Zone areas around the bar code symbol.
  - Undesirable alternative: On the lower-right quadrant of the front, near the edge, respecting the proper Quiet Zone areas around the bar code symbol.

- Edge rule: The bar code symbol cannot be closer than 8 mm (0.3 inches) or farther than 102 mm (4 inches) from any edge of the package/container.

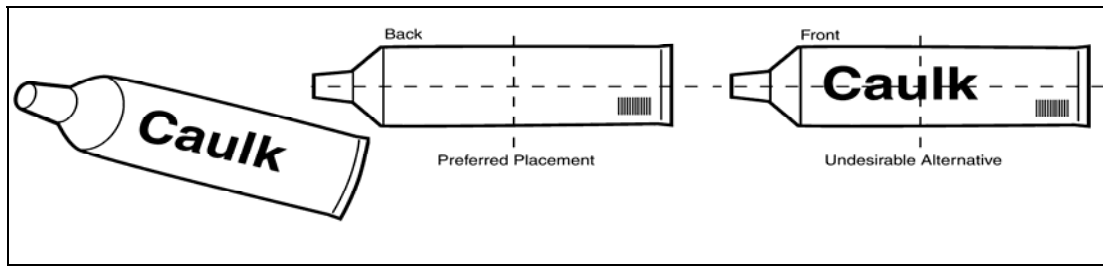

Figure 4.21 – Symbol placement on tubes

#### 4.15 Tubs

Tubs are circular containers (usually made of paper, plastic, or metal) that have removable lids. In most cases, they have spot labels that do not cover the entire surface of the container. Examples include margarine, butter, ice cream, and whipped topping.

- Package characteristics: Deep vessels with removable lids.
- Unique considerations: When a bar code symbol is printed onto a curved surface, it is sometimes possible for the extremes of the symbol to disappear around the curve. See *Appendix A* for the rules on the relationship between the diameter of the item and the X-dimension.
- Bar code symbol placement: Identify the front of the package / container. Refer to *Section 3.2* for instructions on how to identify the package front.
  - Preferred placement: On the lower-right quadrant of the back, near the edge, respecting the proper Quiet Zone areas around the bar code symbol.
  - Undesirable alternative: On the lower-right quadrant of the front, near the edge, respecting the proper Quiet Zone areas around the bar code symbol.
- Edge rule: The bar code symbol cannot be closer than 8 mm (0.3 inches) or farther than 102 mm (4 inches) from any edge of the package / container.

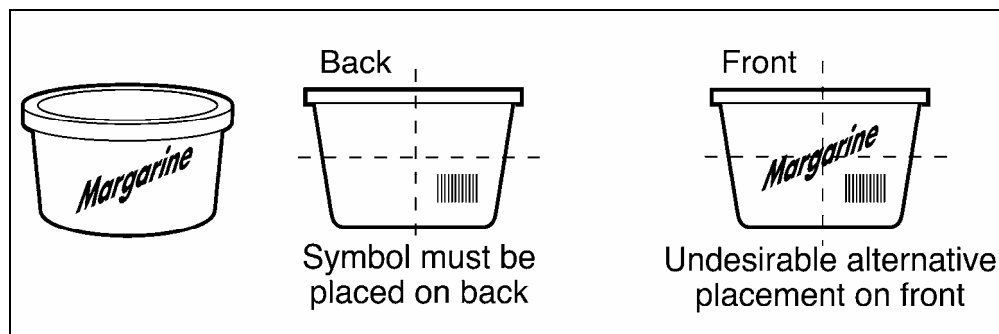

Figure 4.22 – Symbol placement on tubs



## 4.16 Unpackaged Items

These are square, rectangular, circular, concave, or convex shaped items, including bowls, pots, pans, skillets, cups, vases, and other products (with or without contents), that lack an upright surface suitable for symbol placement.

- Package characteristics: These are items that are unpackaged and sold with spot labels, hang tags, or carded sleeves.
- Unique considerations: When selecting symbol placement, consider the product's concave shape on the inside or irregular curvature on the outside while respecting the scanning distances defined in the edge rule below.
- The general marking guideline for a table and giftware items is to use a hang tag. This avoids any damage to the item that could be caused by the spot label adhesive. If this is not practical, apply the spot label to the bottom of the item and below the backstamp (where present).
- Bar code symbol placement: Bar code symbol placement on unpackaged items depends on the shape and type of the item. The following examples illustrate symbol placements appropriate to specific item types.
- Preferred placement: The following figures indicate acceptable placement locations for other shaped items.

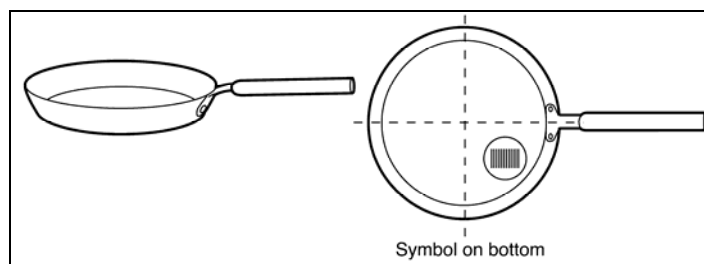

Figure 4.23 – Option 1

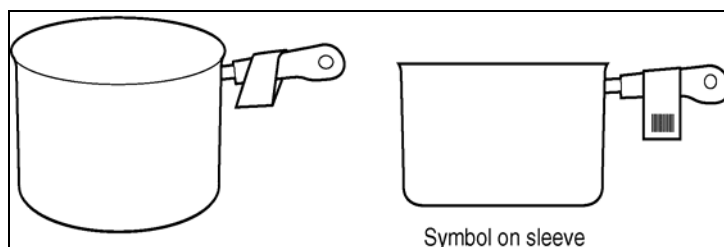

Figure 4.24 – Option 2

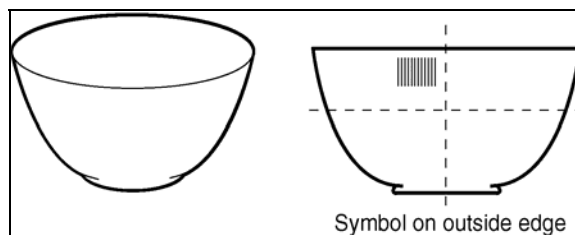

Figure 4.25 – Option 3

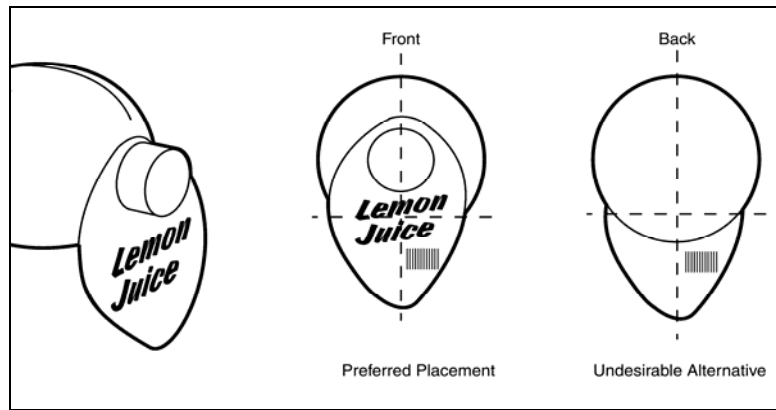

Figure 4.26 – Option 4



Figure 4.27 – Option 5 giftware using hang tag

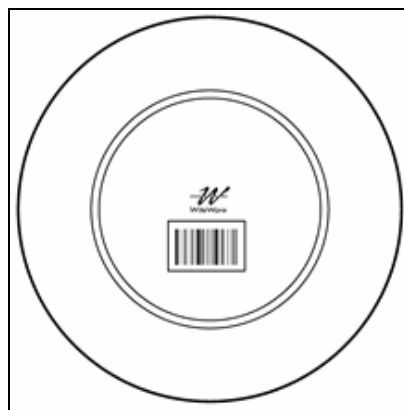

Figure 4.28 – Option 6 tableware using spot label below backstamp

- Undesirable alternative: The undesirable alternative is not applicable.
- Edge rule: The bar code symbol cannot be closer than 8 mm (0.3 inches) or farther than 100 mm (4 inches) from any edge of the package / container.

#### 4.17 Sets (Grouping of individually bar coded items)

For bar coding purposes, sets are defined as two or more items that are packaged and sold together as one unit, regardless of whether those items can be sold separately as well. If the items are packaged together for shipping purposes but are not intended to be sold as a single unit, they do not qualify as a set. Examples of sets include a pair of candlesticks, a set of four soup bowls, and a five-piece dinner place setting.

If a set is not intended to be sold as individual components, only the package for the set needs to be bar coded.

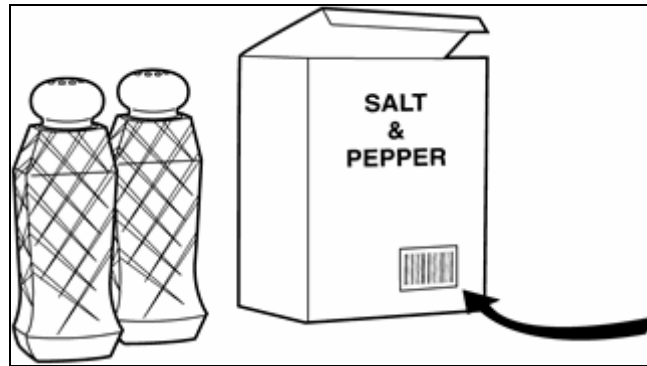

Figure 4.29 – Example of a set where individual components are not sold separately

If the set is made up of components that can be ordered as separate trade items, then the components of the set must be marked. If the set can be sold as individual components or as the set, then both the package and the components need to be marked with unique symbols. The bar code symbols on the inner products must be totally obscured so that they cannot be read by the POS system when sold as a set. See *Section 3.3.6* for over-wrap special considerations.

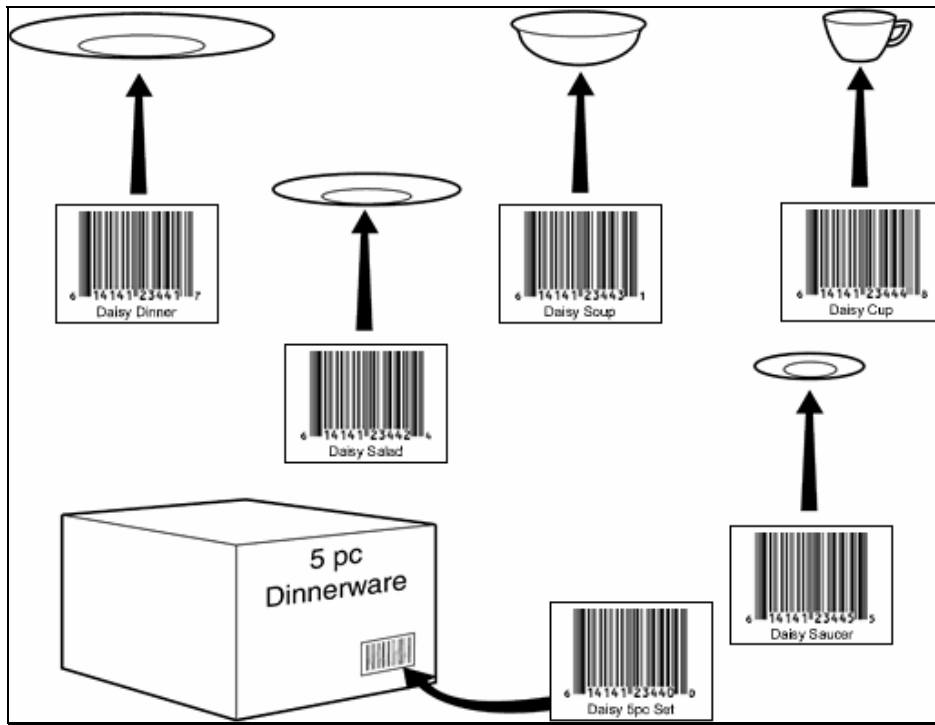

Figure 4.30 – Example of a multi-piece set sold as a set or as individual components

If an item is made up of multiple components that cannot be sold separately such as a teapot with lid, the main piece only should be marked with one symbol. Such items are not considered sets.

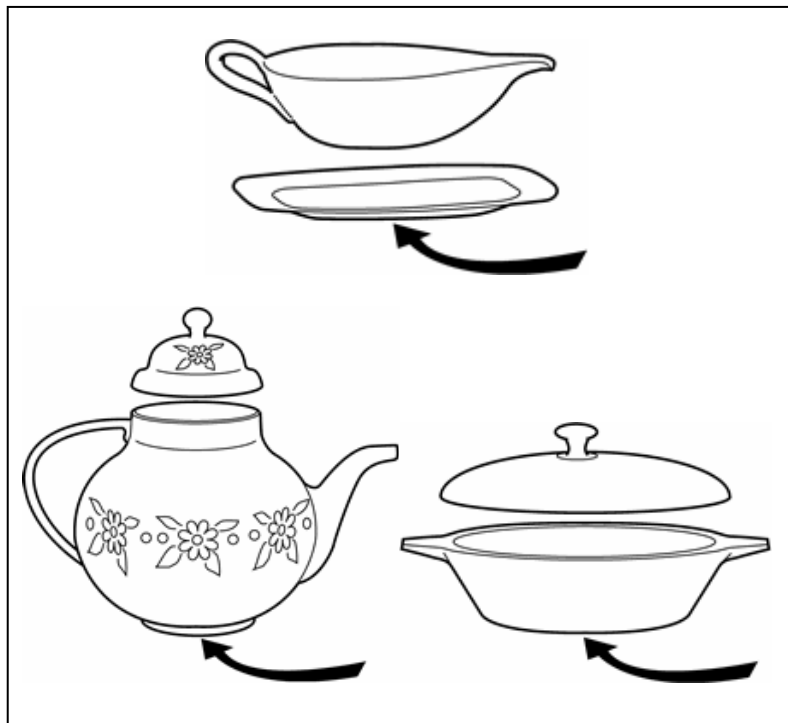

Figure 4.31 – Items with Multiple Pieces that are not Sold Separately (these are not considered sets)

## 4.18 Sporting Goods

Sporting goods provide an excellent example of a category composed of many irregular sized and shaped goods. However, an understanding of each product type, the logistics involved in the supply chain, and the sales floor presentation are key to improving the overall efficiency. Of particular importance is consistent bar code symbol placement as presented at the retail POS. This enables the POS operator to accurately predict the symbol location and thereby improve efficiency.

The following examples, while not exhaustive, provide the general principles that may be applied to similar product types.

### 4.18.1 Archery Bows, Arrows

- Preferred placement:
  - If packaged in boxes, see *Section 4.4*.
  - If packaged using a hang tag, see *Section 4.16*.
- Edge rule: The bar code symbol cannot be closer than 8 mm (0.3 inches) or farther than 100 mm (4 inches) from any edge of the package / container.

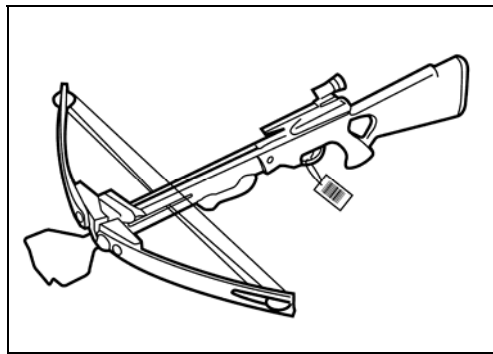

Figure 4.32 – Example bar code location on an archery bow

### 4.18.2 Balls, Team Sports

- Preferred placement:
  - If packaged individually, placement on the shrink wrap.
  - If packaged in boxes or boxed sets, see *Section 4.4*. If a master Stock Keeping Unit (SKU) is not utilized for a boxed set of balls or a pack set of ball and pump, each product type within the pack set should have a screened bar code symbol.
  - If not packaged, screen the bar code symbol on the opposite side of the logo on the ball.
- Edge rule: The bar code symbol cannot be closer than 8 mm (0.3 inches) or farther than 100 mm (4 inches) from any edge of the package / container.

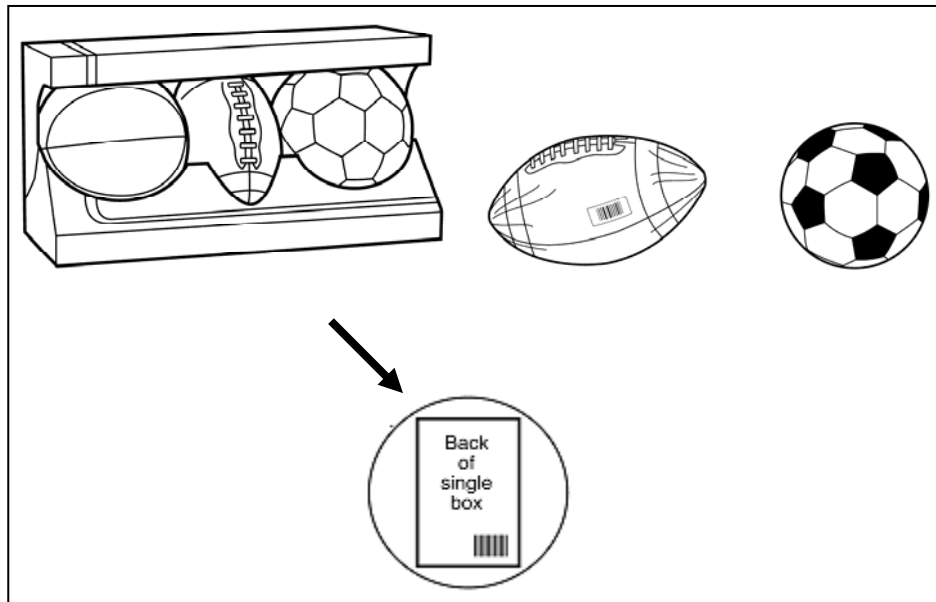

Figure 4.33 – Example bar code locations on a box of balls & separate balls

#### 4.18.3 Bats, Team Sports

- Preferred placement: On the barrel handle of the bat, respecting the proper Quiet Zone areas around the bar code symbol.
- Edge rule: The bar code symbol cannot be closer than 8 mm (0.3 inches) or farther than 100 mm (4 inches) from any edge of the package / container.

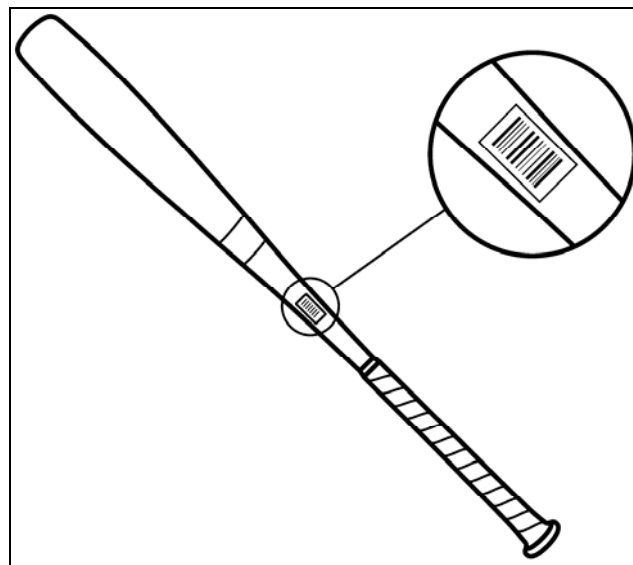

Figure 4.34 – Example bar code location on a baseball bat

#### 4.18.4 Bicycles

- Preferred placement: On the right fork of the bike, respecting the proper Quiet Zone areas around the bar code symbol.
- Undesirable alternative: On a hang tag around the right brake cable, respecting the proper Quiet Zone areas around the bar code symbol.
- Edge rule: The bar code symbol cannot be closer than 8 mm (0.3 inches) or farther than 100 mm (4 inches) from any edge of the package / container.

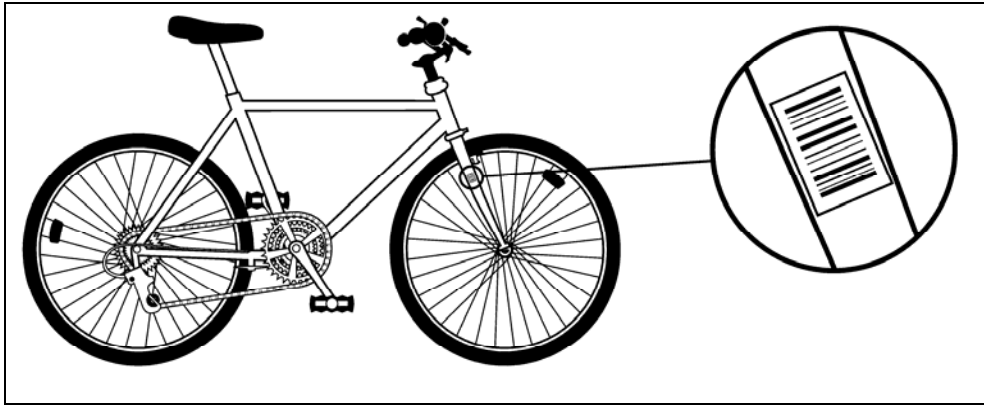

Figure 4.35 – Example bar code location on a bicycle

#### 4.18.5 Climbing Gear

- Preferred placement:
  - If packaged in boxes, see *Section 4.4*.
  - If packaged using a hang tag, see *Section 4.16*.
  - If packaged as carded items, see *Section 4.6*.
- Edge rule: The bar code symbol cannot be closer than 8 mm (0.3 inches) or farther than 100 mm (4 inches) from any edge of the package / container.

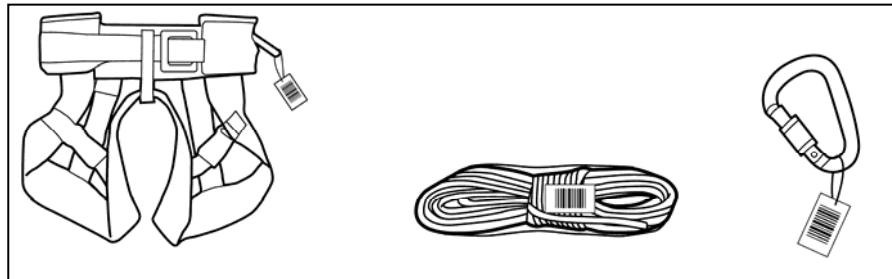

Figure 4.36 – Example bar code locations on climbing gear

#### 4.18.6 Fishing Rods

- Preferred placement: On the grip of the fishing rod near the sealed end, respecting the proper Quiet Zone areas around the bar code symbol. When a bar code symbol is printed onto a curved surface it is sometimes possible for the extremes of the symbol to disappear around the curve. See *Appendix A* for the rules on the relationship between the diameter of the item and the X-dimension.
- Undesirable alternative: On a cardboard wrap or a hang tag on the shaft of the fishing rod, respecting the proper Quiet Zone areas around the bar code symbol.
- Edge rule: The bar code symbol cannot be closer than 8 mm (0.3 inches) or farther than 100 mm (4 inches) from any edge of the package / container.

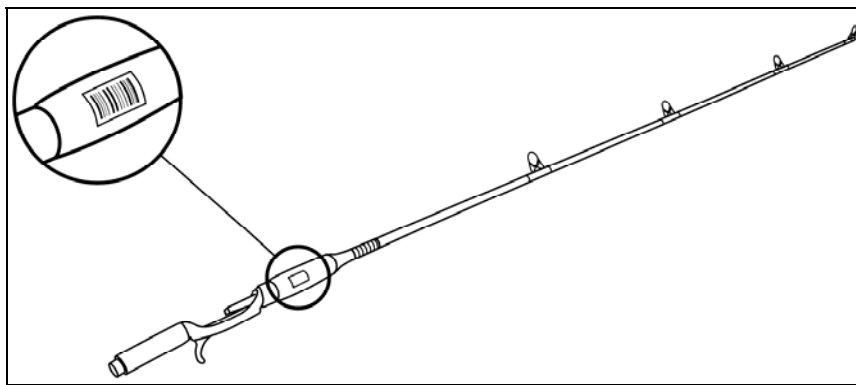

Figure 4.37 – Example bar code location on a fishing rod

#### 4.18.7 Fitness Accessories

- Preferred placement:
  - If packaged in boxes, see *Section 4.4*.
  - If packaged using hang tags, see *Section 4.16*.
  - If packaged as a carded item, see *Section 4.6*.
- Edge rule: The bar code symbol cannot be closer than 8 mm (0.3 inches) or farther than 100 mm (4 inches) from any edge of the package / container.

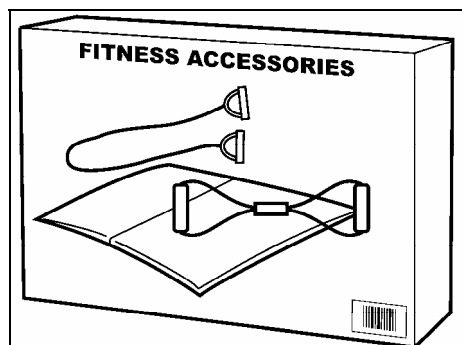

Figure 4.38 – Example bar code location on a box of fitness accessories



#### 4.18.8 Gloves, Mitts (Sports)

- Preferred placement:
  - If packaged in boxes, see *Section 4.4*.
  - If packaged using hang tags, see *Section 4.16*.
  - If packaged in bags, see *Section 4.1*.
  - If not packaged, see *Section 4.16*.
- Edge rule: The bar code symbol cannot be closer than 8 mm (0.3 inches) or farther than 100 mm (4 inches) from any edge of the package / container.

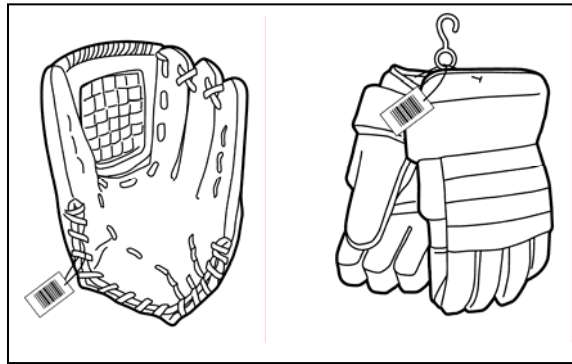

Figure 4.39 – Example bar code locations on gloves

#### 4.18.9 Golf Clubs

- Preferred placement: On the shaft of the club located near the club head, respecting the proper Quiet Zone areas around the bar code symbol. When a bar code symbol is printed on a curved surface, it is sometimes possible for the extremes of the symbol to disappear around the curve. See *Appendix A* for the rules on the relationship between the diameter of the item and the X-dimension. Symbols should not be located on the head of the golf club as symbols located on this flat area (typically preferable to locating bar codes on a curved surface) are easily damaged due to customer trials.
- Undesirable alternative: On the grip of the club near the sealed end, respecting the proper Quiet Zone areas around the bar code symbol.
- Edge rule: The bar code symbol cannot be closer than 8 mm (0.3 inches) or farther than 100 mm (4 inches) from any edge of the package / container.

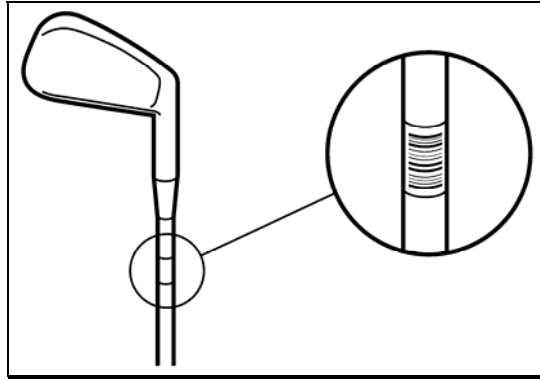

Figure 4.40 – Example bar code location on a golf club

#### 4.18.10 Guns

- Preferred placement:
  - If packaged using a hang tag, see *Section 4.16*.
  - If packaged as a blister pack, see *Section 4.2*.
  - If not packaged, placement near serial number.
- Edge rule: The bar code symbol cannot be closer than 8 mm (0.3 inches) or farther than 100 mm (4 inches) from any edge of the package / container.

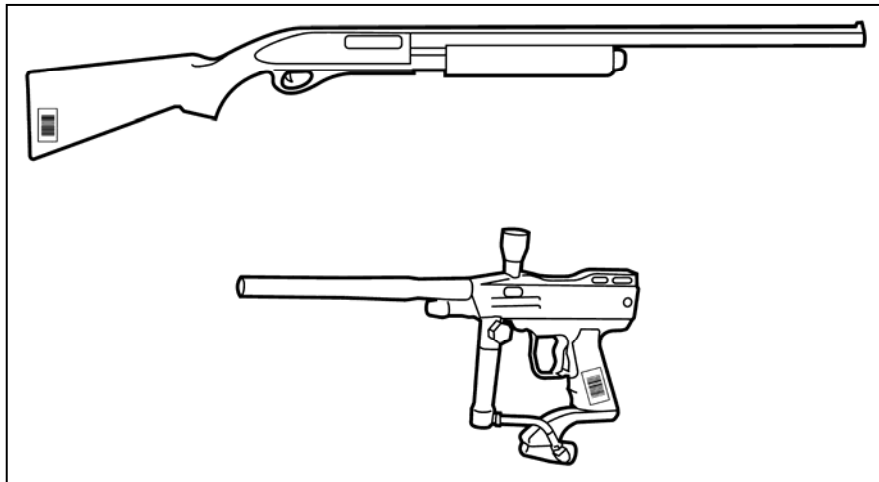

Figure 4.41 – Example bar code locations on a rifle and paint ball gun

#### 4.18.11 Helmets, Masks (Sports)

- Preferred placement:
  - If packaged in boxes, see *Section 4.4*.
  - If packaged using hang tags, see *Section 4.16*.
  - If not packaged, see *Section 4.16*.
- Edge rule: The bar code symbol cannot be closer than 8 mm (0.3 inches) or farther than 100 mm (4 inches) from any edge of the package / container.

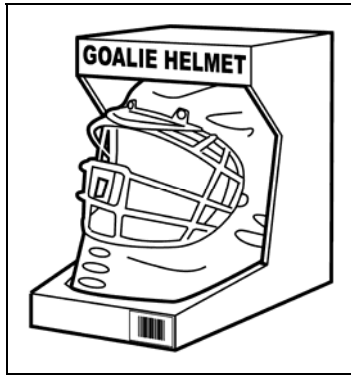

Figure 4.42 – Example bar code location on a helmet

#### 4.18.12 Ice Hockey and Field Hockey

- Preferred placement: On the flat blade of the stick, respecting the proper Quiet Zone areas around the bar code symbol.
- Undesirable alternative: At the very top of the shaft of the stick, respecting the proper Quiet Zone areas around the bar code symbol. When a bar code symbol is printed on a curved surface, it is sometimes possible for the extremes of the symbol to disappear around the curve. See *Appendix A* for the rules on the relationship between the diameter of the item and the X-dimension.
- Edge rule: The bar code symbol cannot be closer than 8 mm (0.3 inches) or farther than 100 mm (4 inches) from any edge of the package / container.

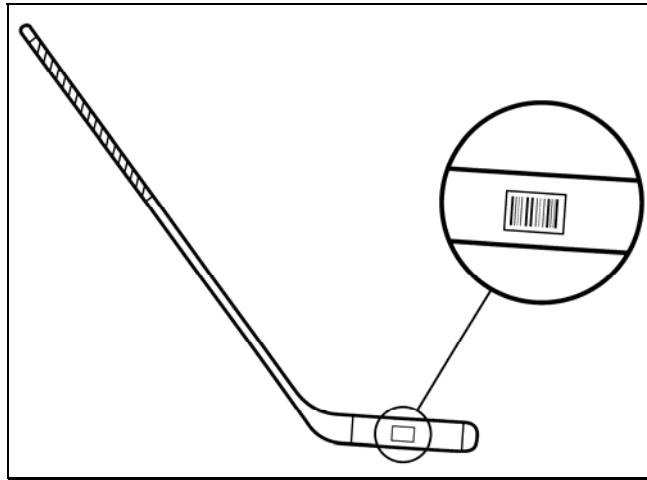

Figure 4.43 – Example bar code location on an ice-hockey stick

#### 4.18.13 Multi-Sports-Product Pack Sets

- Preferred placement:
  - For placement on bags, see *Section 4.1*.
  - For placement on hang tags, see *Section 4.16*.
- Edge rule: The bar code symbol cannot be closer than 8 mm (0.3 inches) or farther than 100 mm (4 inches) from any edge of the package / container.

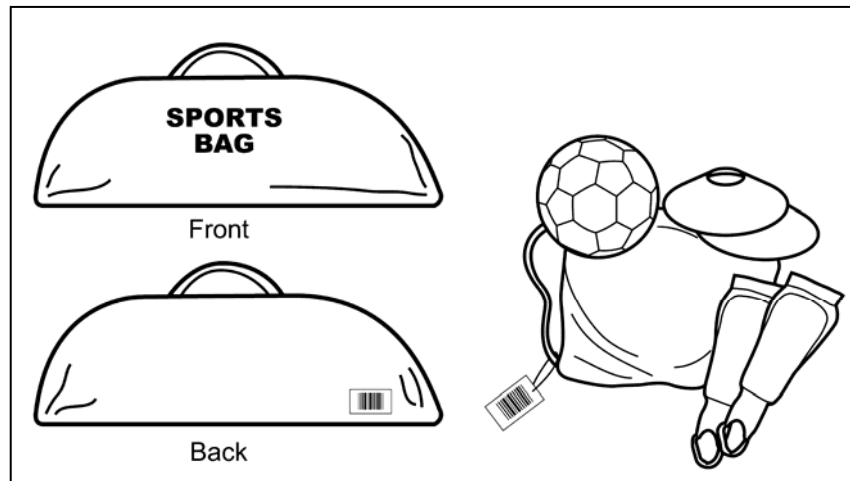

Figure 4.44 – Example bar code location on a product pack

#### 4.18.14 Pressure Gauges

- Preferred placement:
  - If packaged as carded items, see *Section 4.6*.
  - If packaged in bags, see *Section 4.1*.
  - If not packaged, place on the wrap band securing the tip / needles, etc.
- Edge rule: The bar code symbol cannot be closer than 8 mm (0.3 inches) or farther than 100 mm (4 inches) from any edge of the package / container.

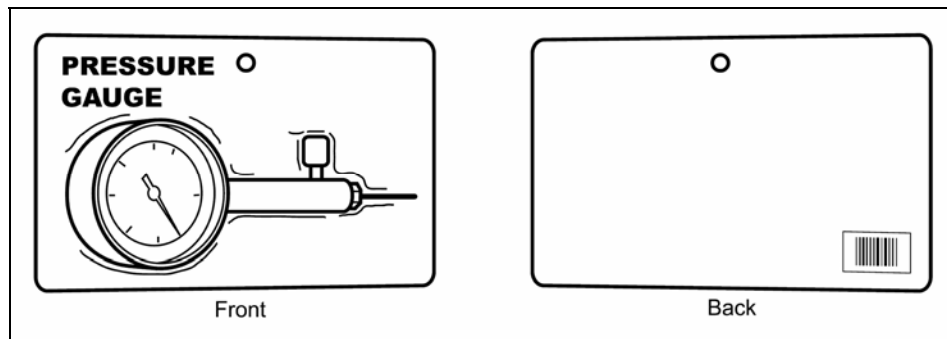

Figure 4.45 – Example bar code location on a carded item

#### 4.18.15 Protective Gear, Guards, Vests

- Preferred placement:
  - If packaged as a carded item, see *Section 4.6*.
  - If not packaged, see *Section 4.16*.
- Edge rule: The bar code symbol cannot be closer than 8 mm (0.3 inches) or farther than 100 mm (4 inches) from any edge of the package / container.

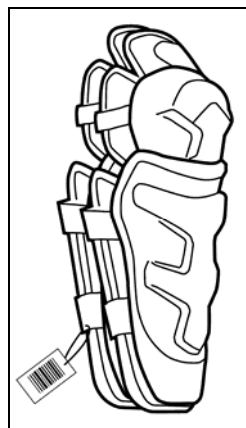

Figure 4.46 – Example bar code location on guards

#### 4.18.16 Pumps (Sports)

- Preferred placement:
  - If packaged as carded items, see *Section 4.6*.
  - If not packaged, place on the wrap band securing the tip / needles, etc.
- Edge rule: The bar code symbol cannot be closer than 8 mm (0.3 inches) or farther than 100 mm (4 inches) from any edge of the package / container.

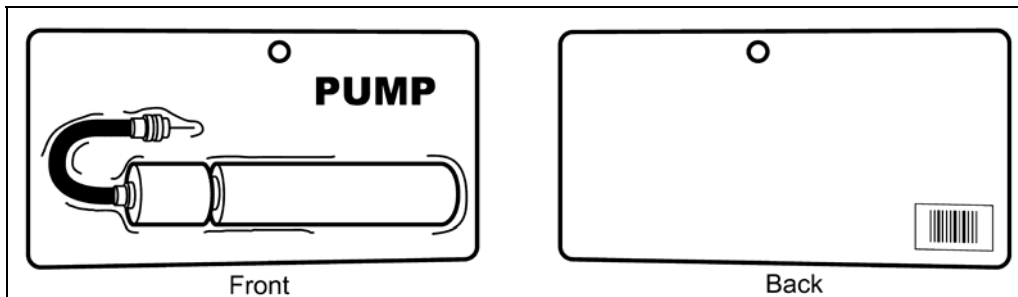

Figure 4.47 – Example bar code location on carded item

#### 4.18.17 Racquets

- Preferred placement: On the grip of the racquet near the sealed end, respecting the proper Quiet Zone areas around the bar code symbol. When a bar code symbol is printed on a curved surface, it is sometimes possible for the extremes of the symbol to disappear around the curve. See *Appendix A* for the rules on the relationship between the diameter of the item and the X-dimension.
- Undesirable alternative: On the cardboard wrap placed over the head of the racquet near the edge of the racquet head, respecting the proper Quiet Zone areas around the bar code symbol.
- Edge rule: The bar code symbol cannot be closer than 8 mm (0.3 inches) or farther than 100 mm (4 inches) from any edge of the package / container.

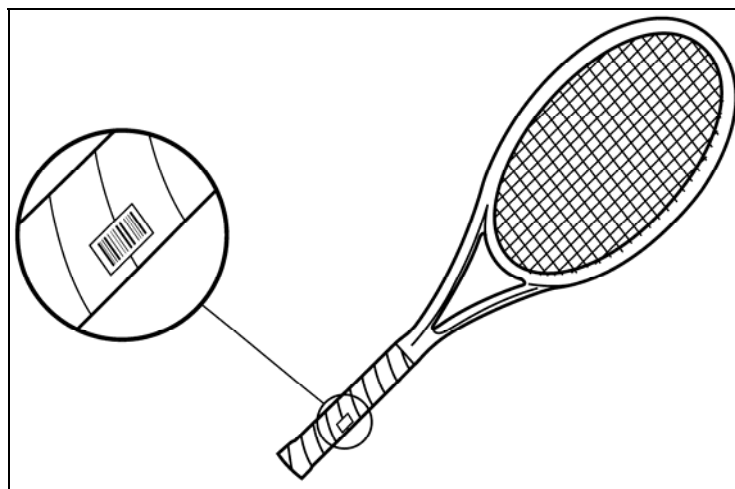

Figure 4.48 – Example bar code location on a racquet

#### 4.18.18 Skateboards

Skateboards are often displayed in their packages.

For unpackaged items:

- Preferred placement: One bar code symbol is placed on the bottom side of the skateboard on the top above the wheels, respecting the proper Quiet Zone areas around the bar code symbol.
- Edge rule: The bar code symbol cannot be closer than 8 mm (0.3 inches) or farther than 100 mm (4 inches) from any edge of the package / container.

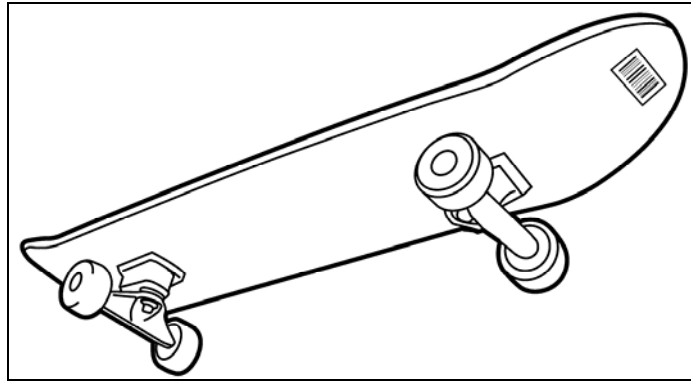

Figure 4.49 – Example bar code location on a skateboard

#### 4.18.19 Skates

- Preferred placement:
  - If packaged in boxes, see *Section 4.4*.
  - If packaged using hang tags, see *Section 4.16*.
- Edge rule: The bar code symbol cannot be closer than 8 mm (0.3 inches) or farther than 100 mm (4 inches) from any edge of the package / container.

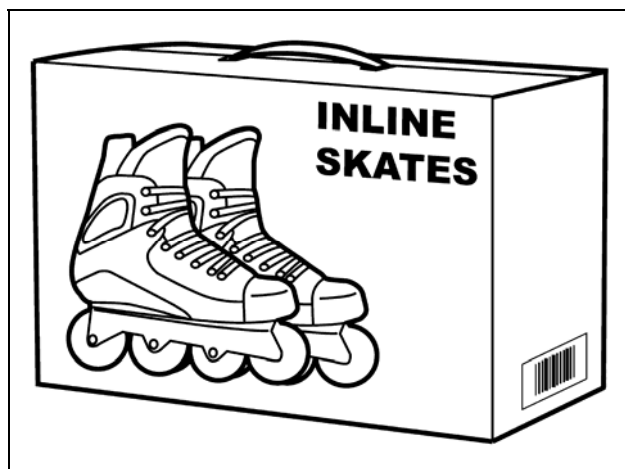

Figure 4.50 – Example bar code location on a box of skates

#### 4.18.20 Skis

Skis are displayed without their packaging. The orientation of the ski is that the front of the ski is the side where the ski boots are placed and the back of the ski is the opposite side.

- Preferred placement: One bar code symbol is placed on the back of the ski near the top of the ski, respecting the proper Quiet Zone areas around the bar code symbol. Only one bar code symbol is required per pair.
- Edge rule: The bar code symbol cannot be closer than 8 mm (0.3 inches) or farther than 100 mm (4 inches) from any edge of the package / container.

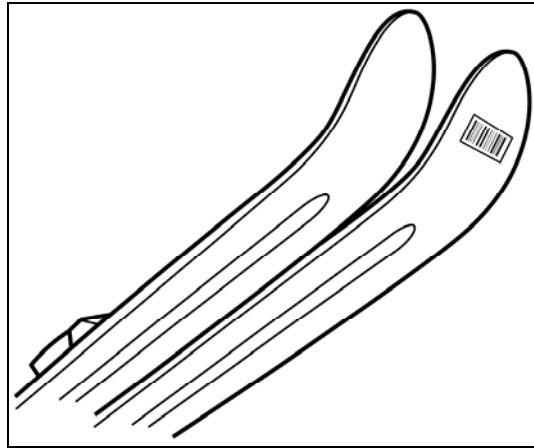

Figure 4.51 – Example bar code location on a ski

#### 4.18.21 Water Bottles (Sports)

- Preferred placement:
  - If packaged in boxes, see *Section 4.4*.
  - If packaged using hang tags, see *Section 4.16*.
  - If not packaged, place on the side of the bottle.
- Edge rule: The bar code symbol cannot be closer than 8 mm (0.3 inches) or farther than 100 mm (4 inches) from any edge of the package / container.

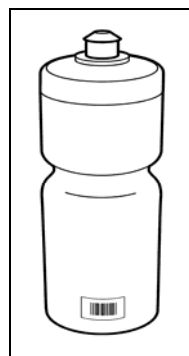

Figure 4.52 – Example bar code location on a water bottle



#### 4.18.22 Water Sports Crafts

- Preferred placement:
  - If packaged in boxes, see *Section 4.4*.
  - If packaged using a hang tag, see *Section 4.16*.
  - If not packaged, see *Section 4.9*.
- Edge rule: The bar code symbol cannot be closer than 8 mm (0.3 inches) or farther than 100 mm (4 inches) from any edge of the package / container.

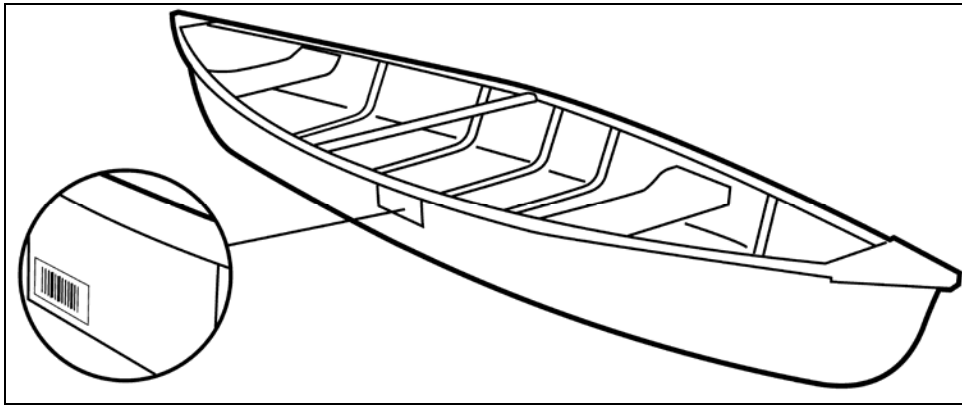

Figure 4.53 – Example bar code location on a canoe

#### 4.19 Textured Surfaces

Some merchandise may not allow for application of bar code labels due to rough or textured surfaces. These surfaces can distort the label and thus the bar code. Alternative labeling options such as hang tags or loop tags may be necessary.

# 5 Symbol Placement for Clothing and Fashion Accessories

The following examples show recommended placement of symbols on clothing and fashion accessories.

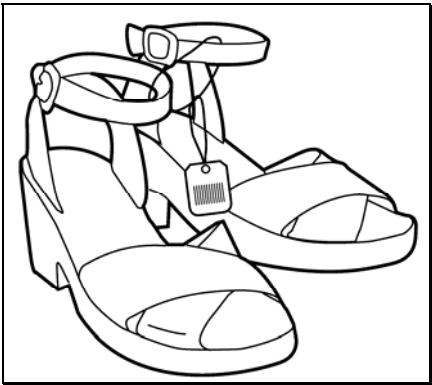
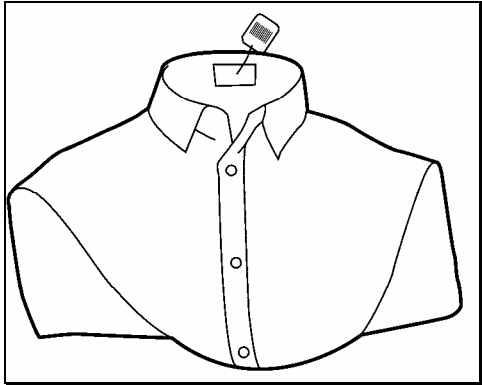
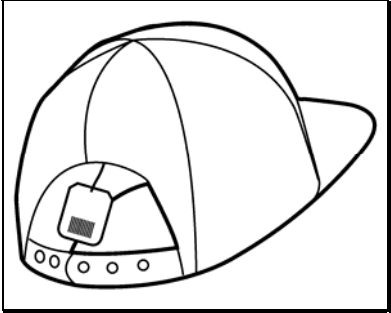
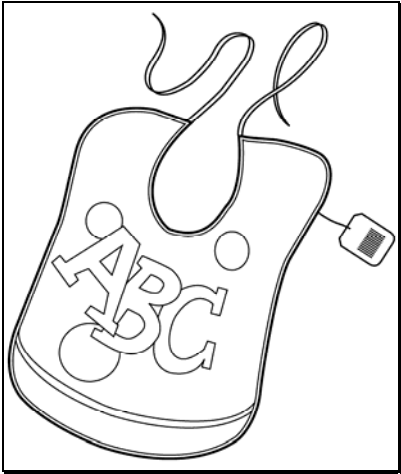
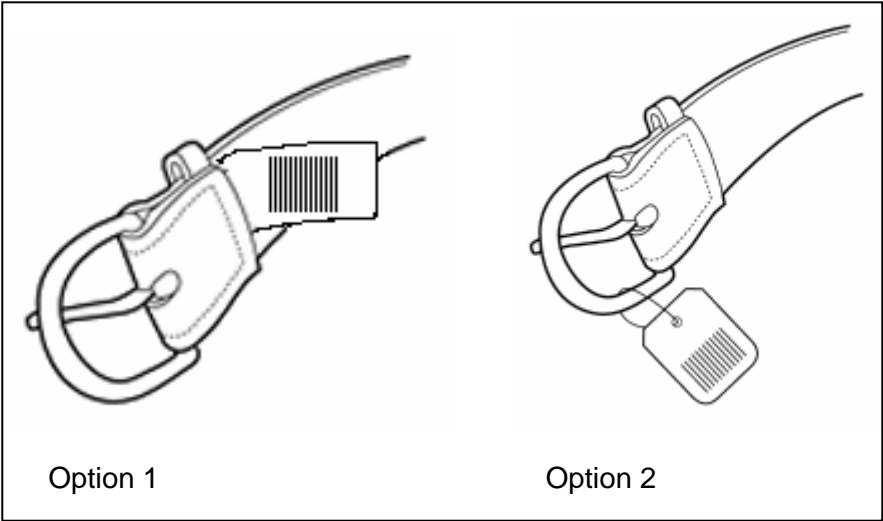

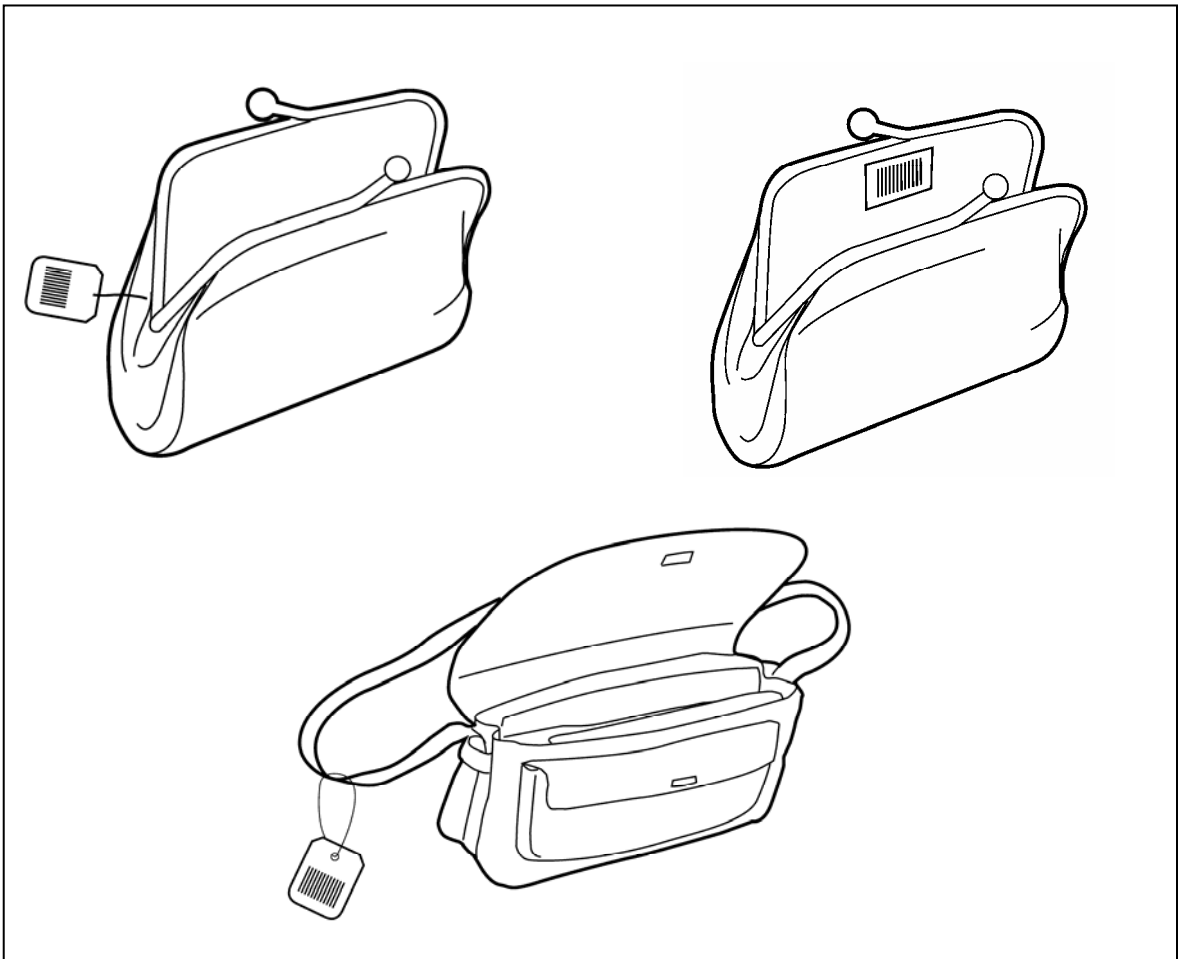
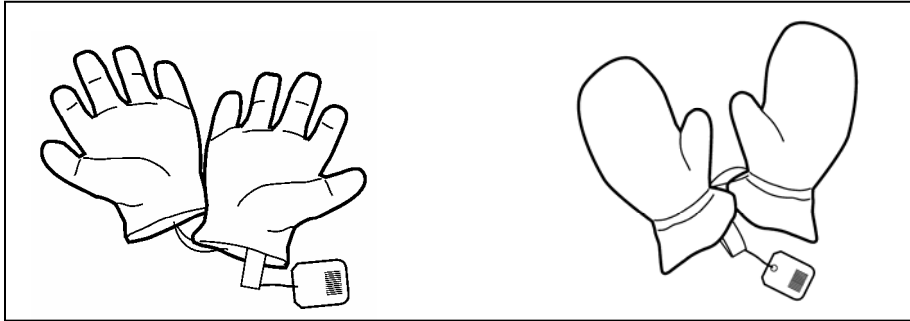
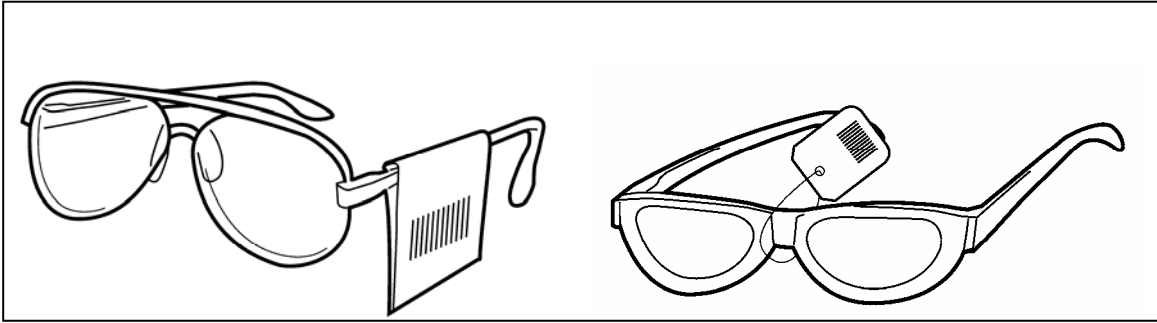

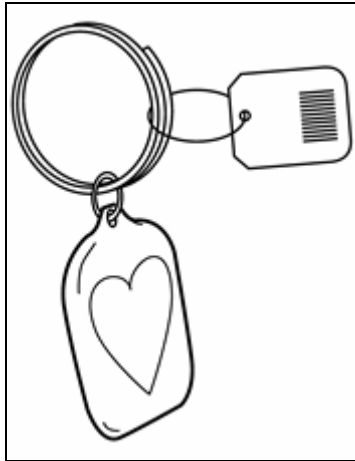
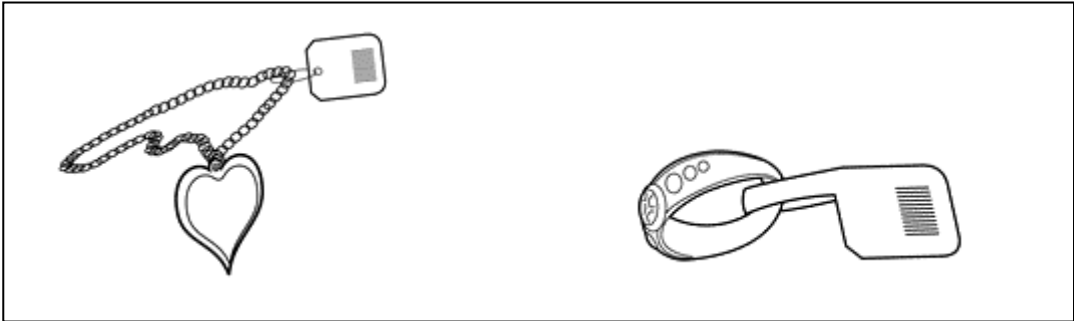
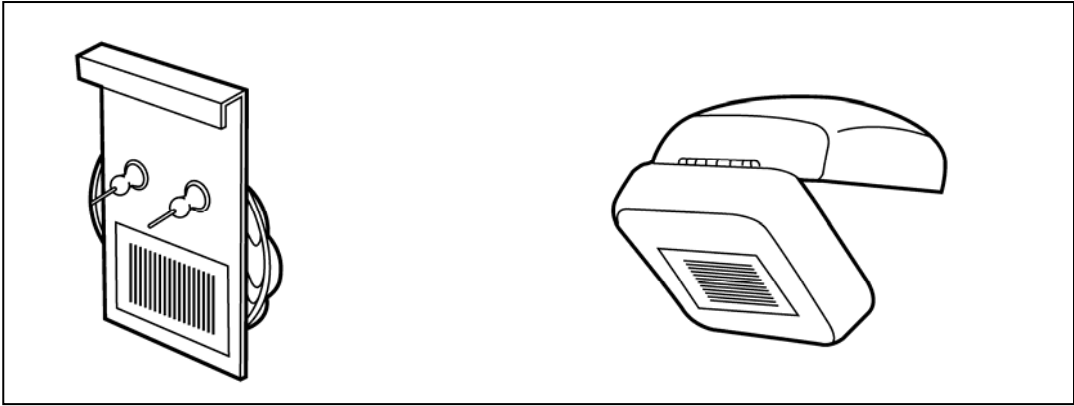
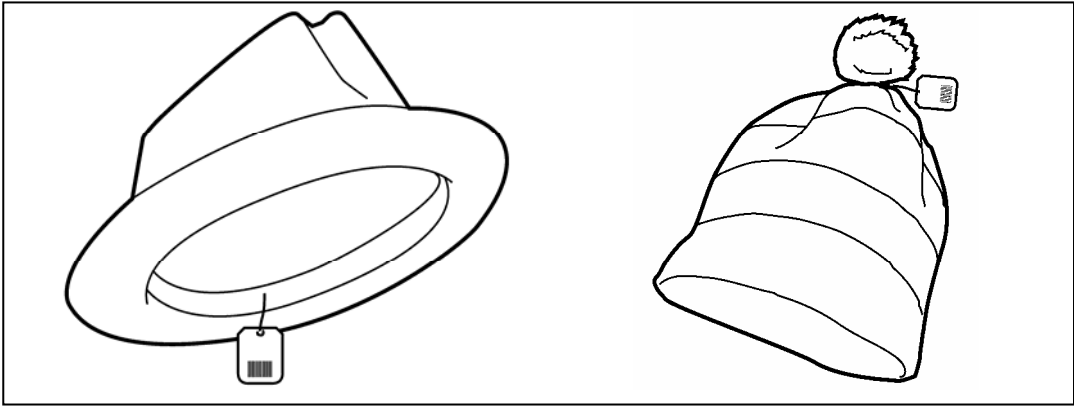

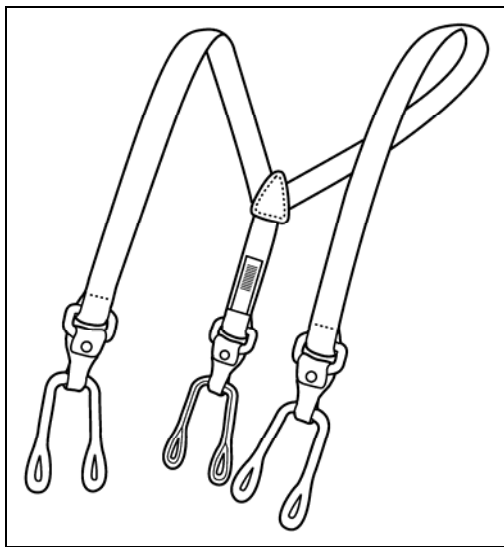
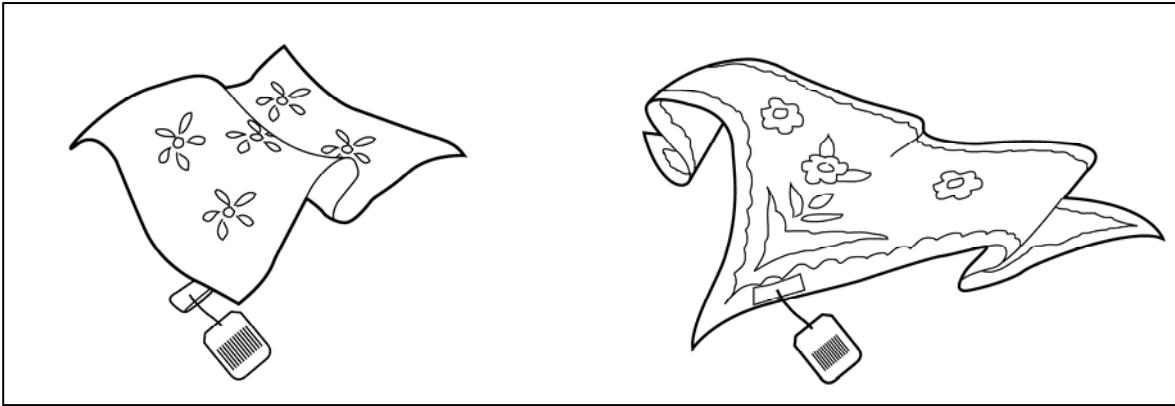
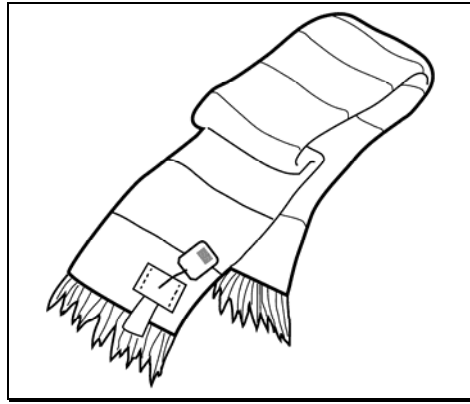
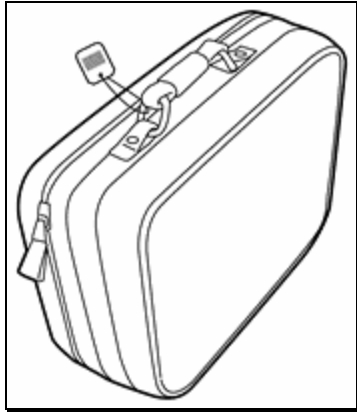

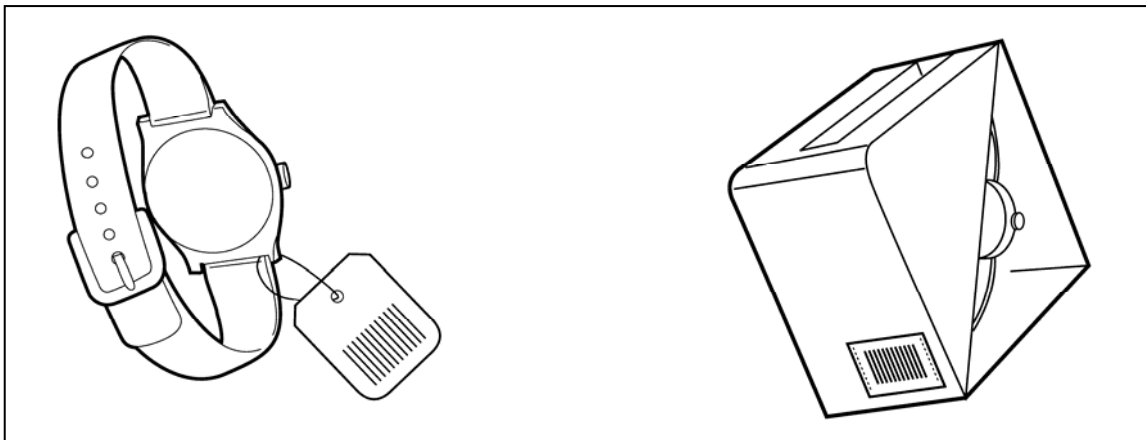
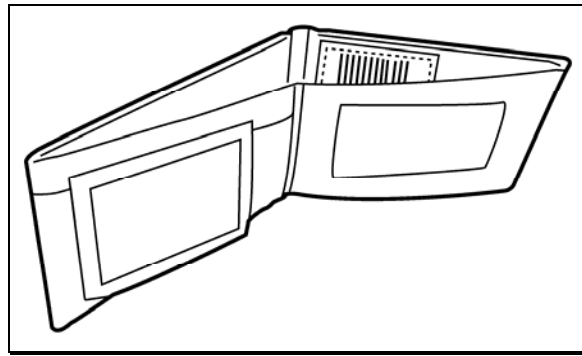
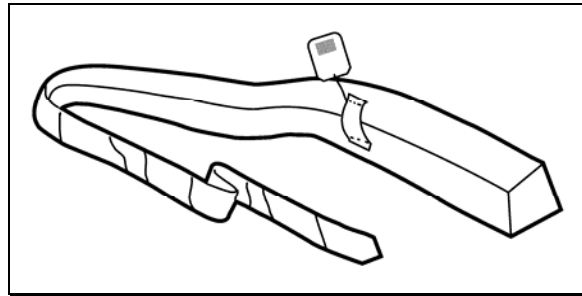
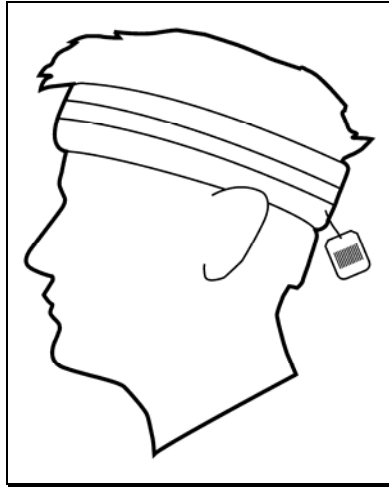

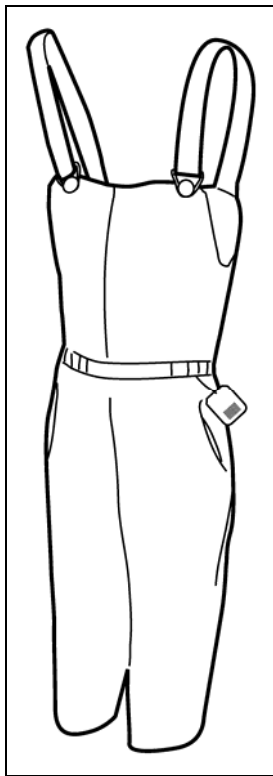
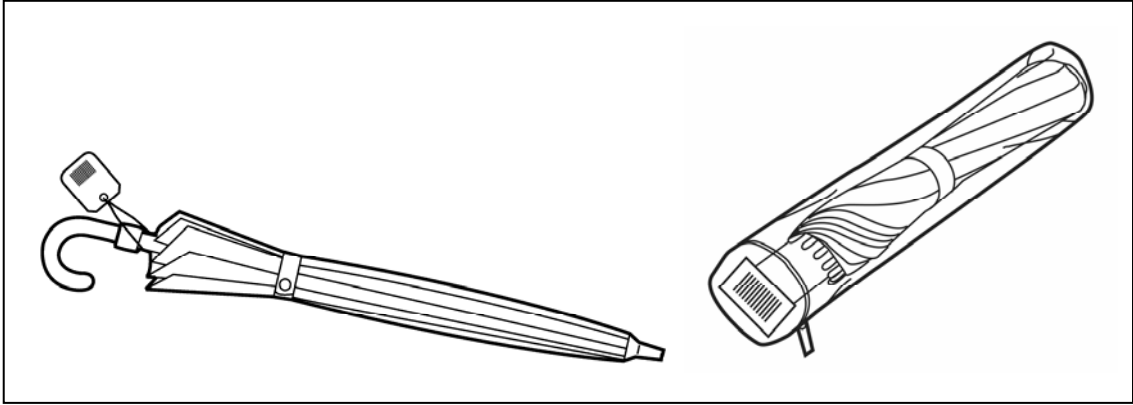

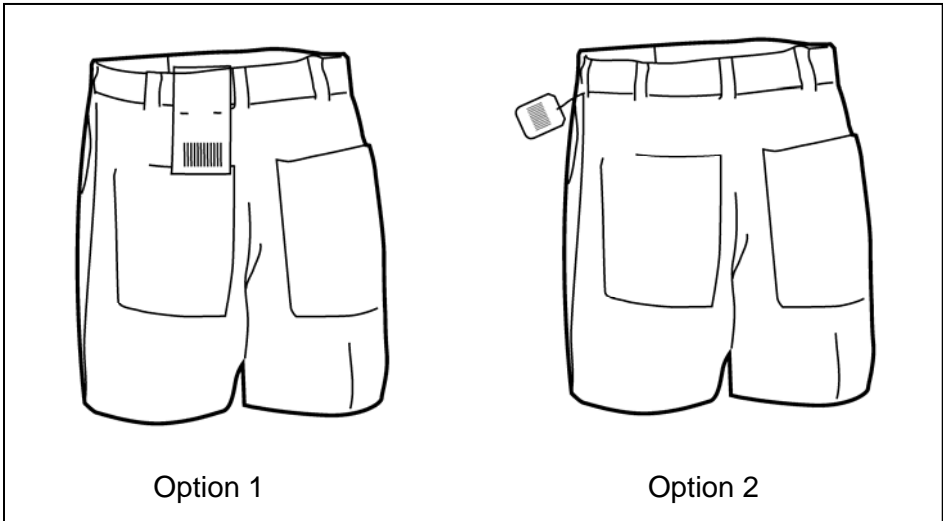
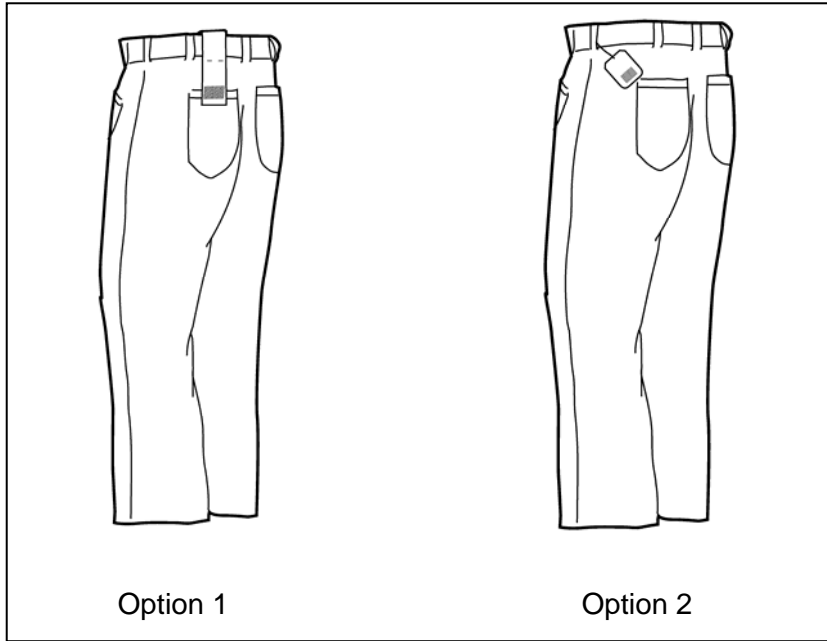
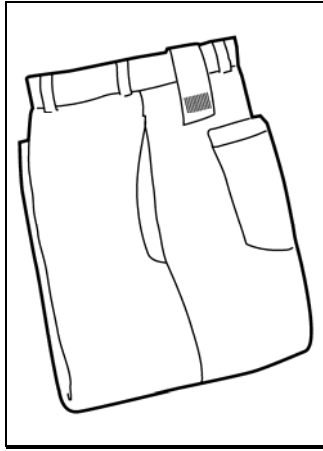



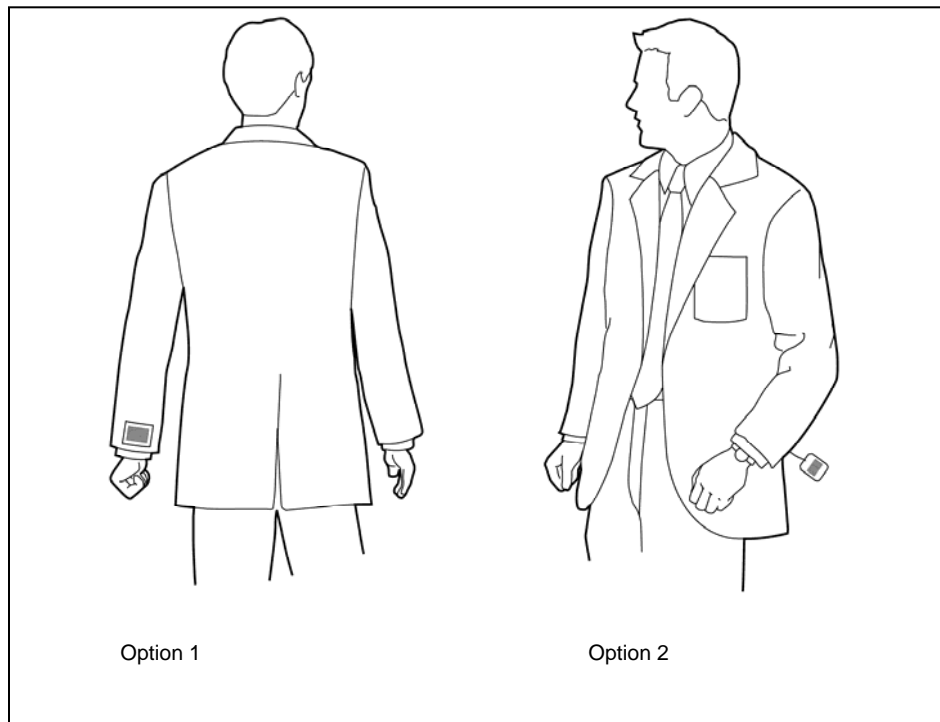
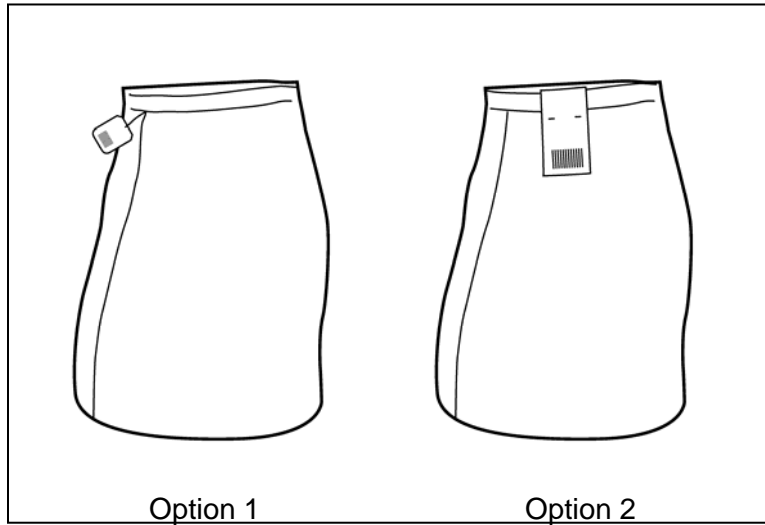

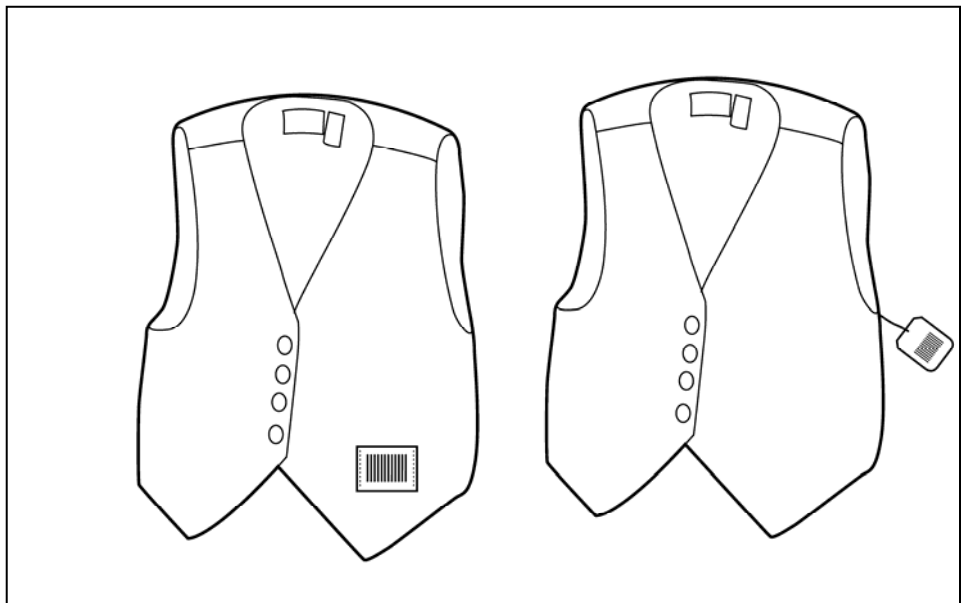
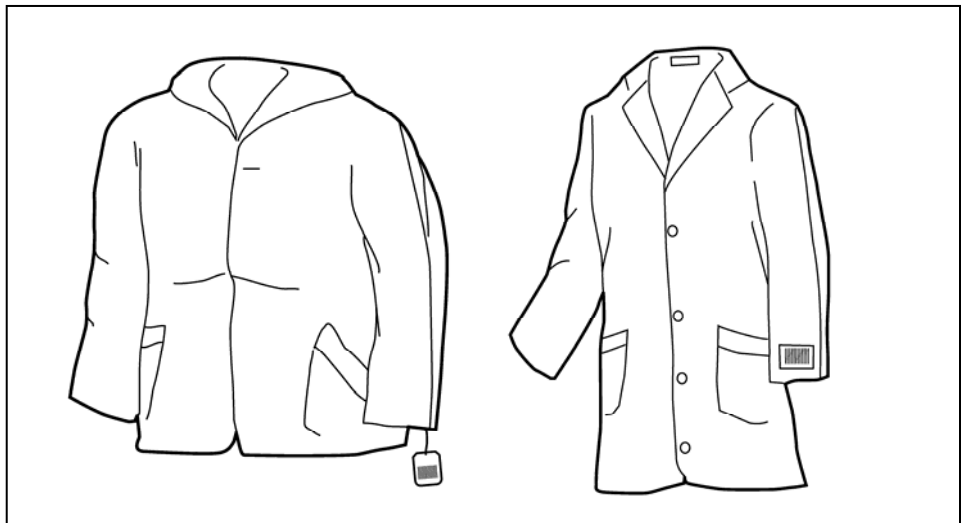

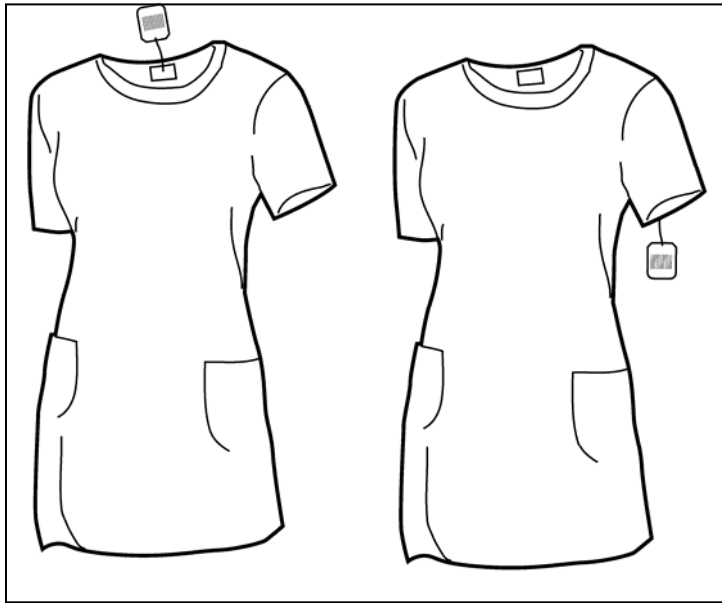
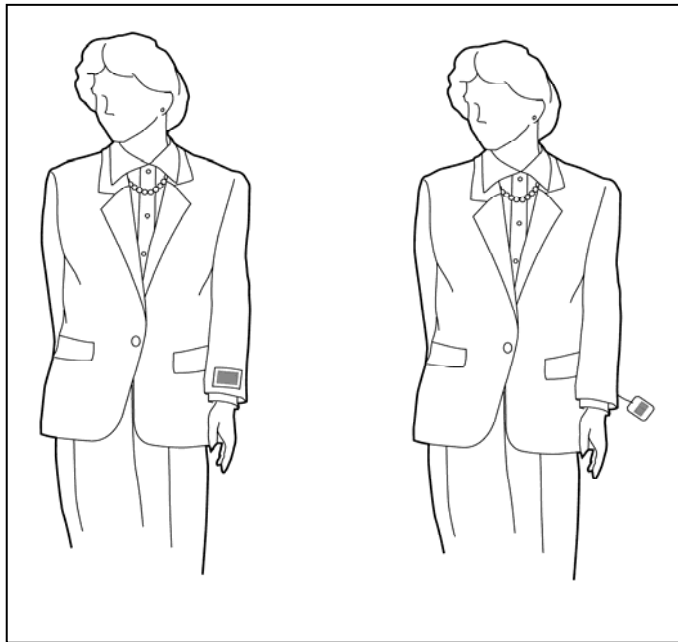

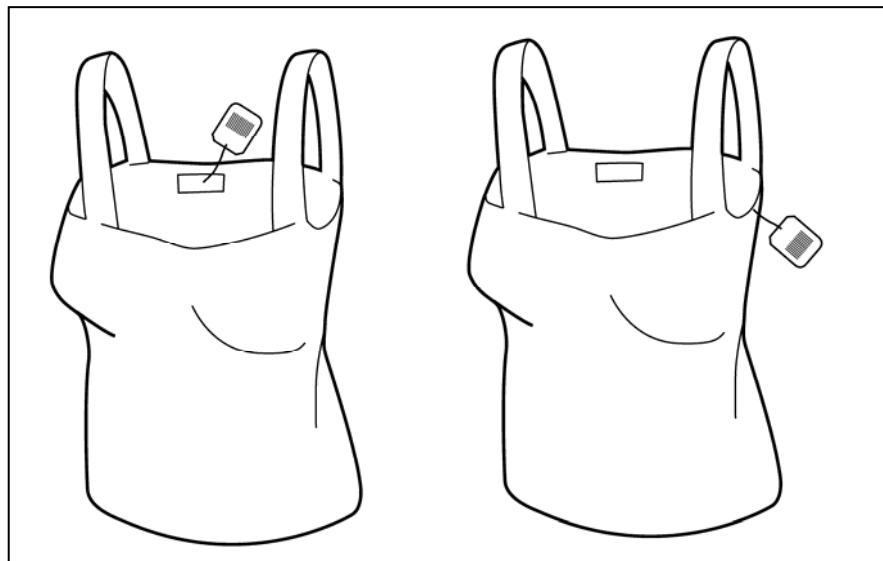
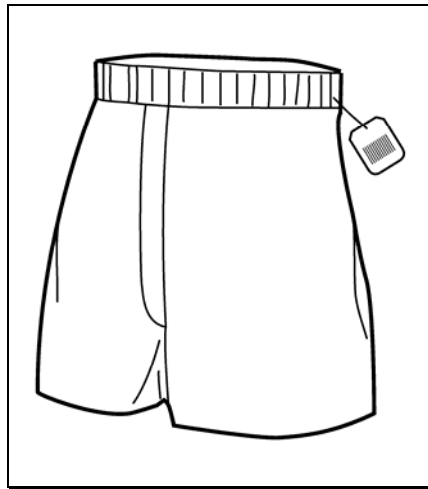
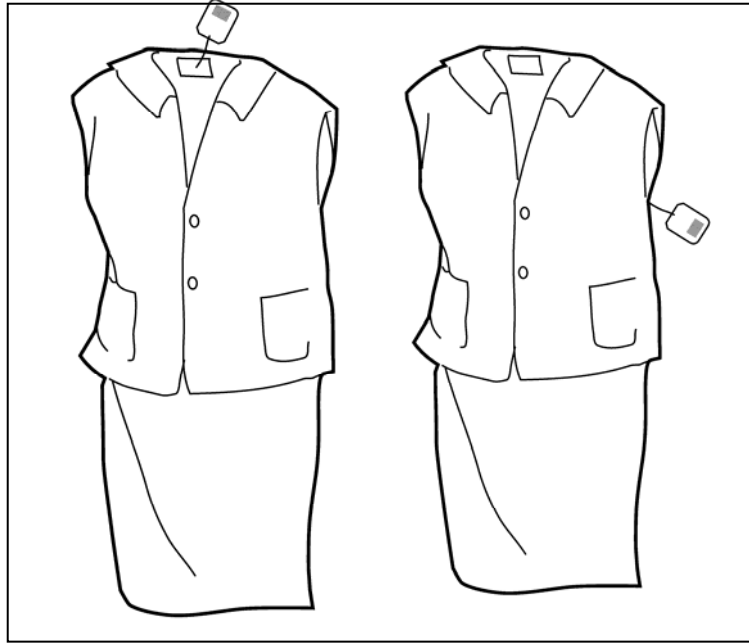

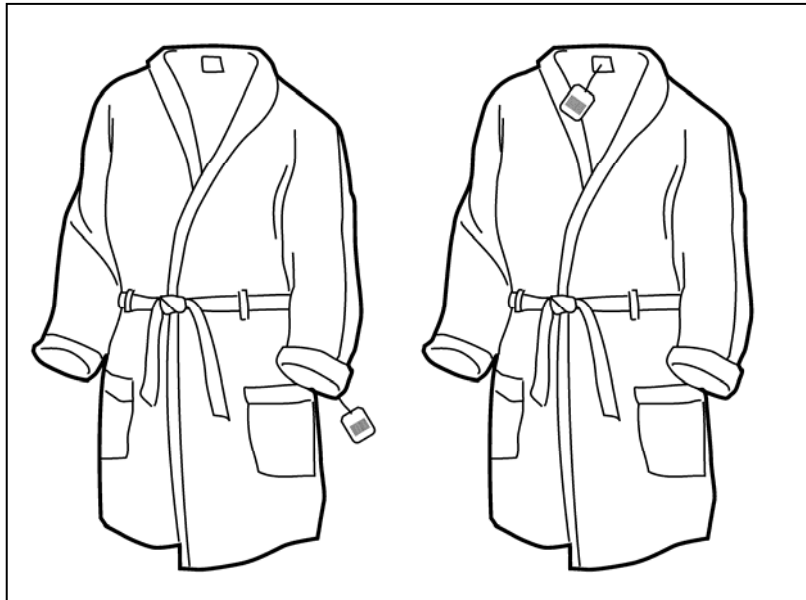
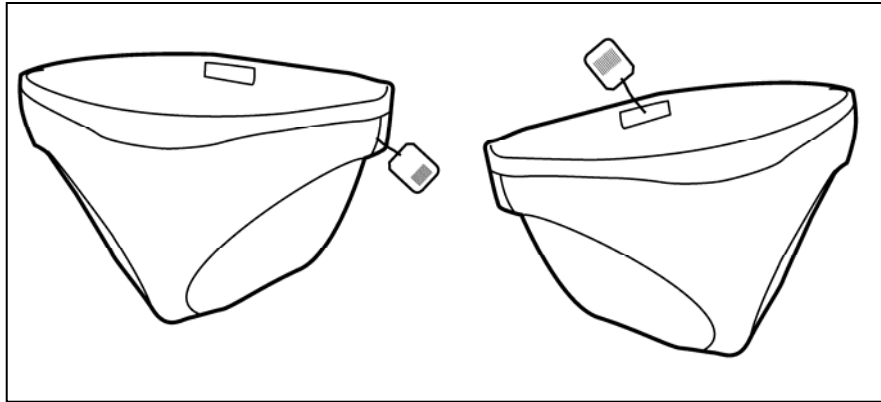

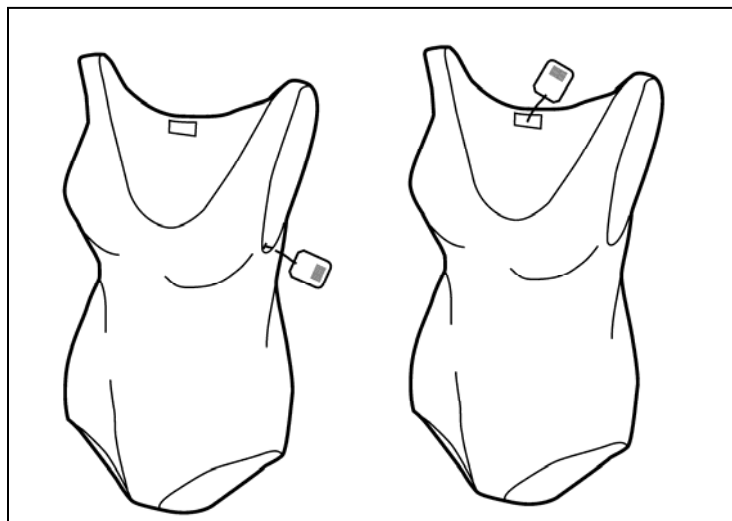
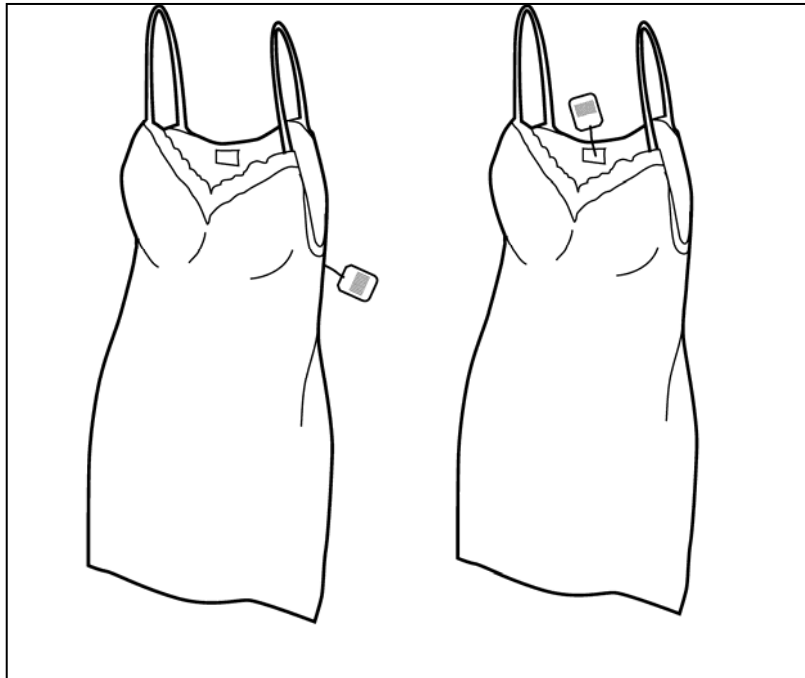

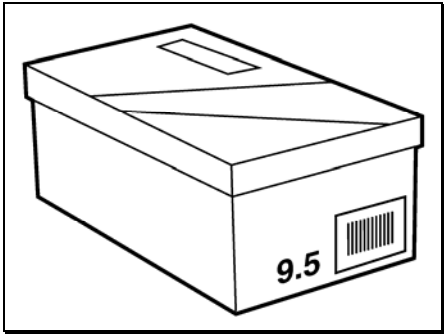
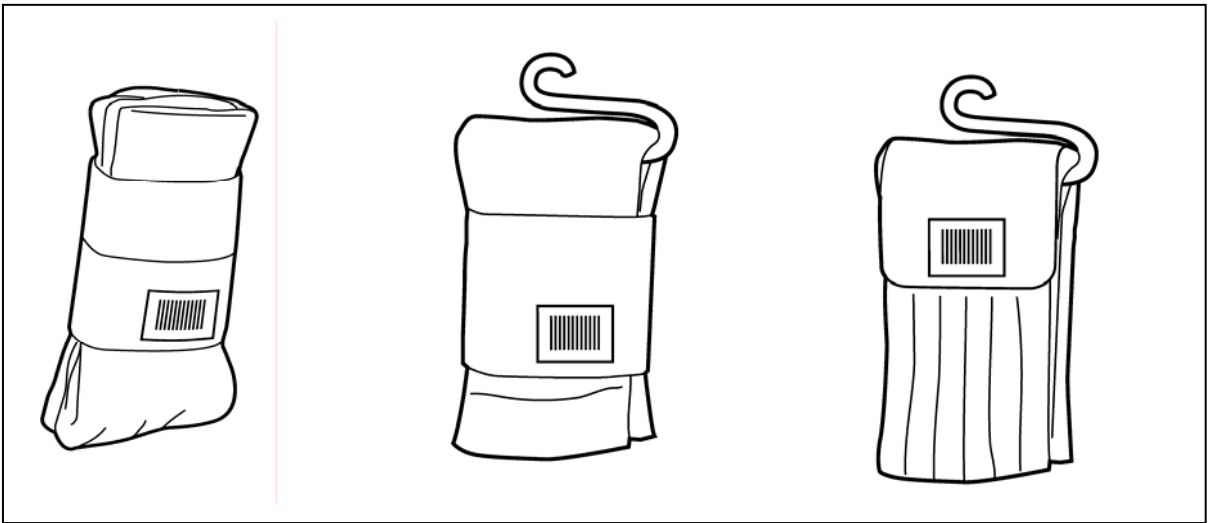
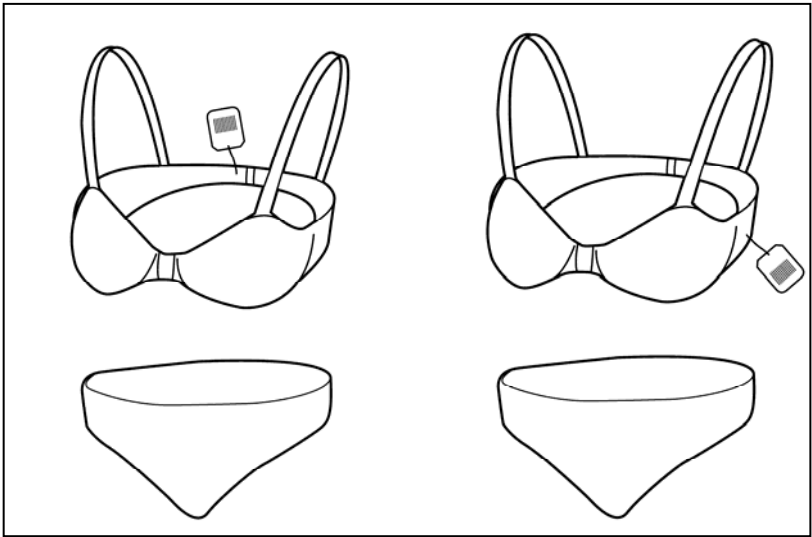

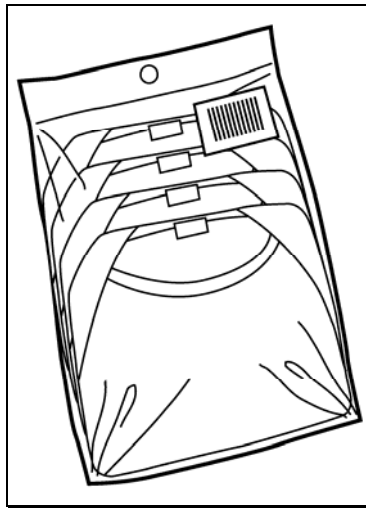
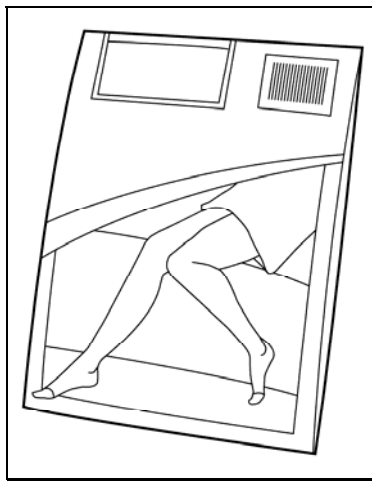
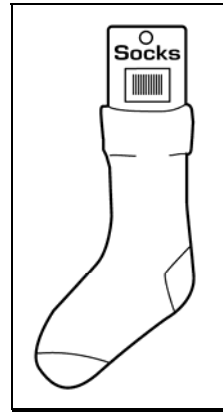
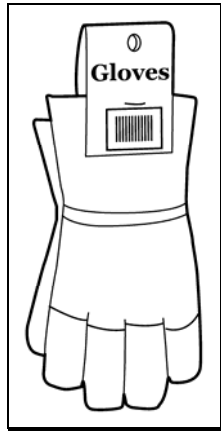



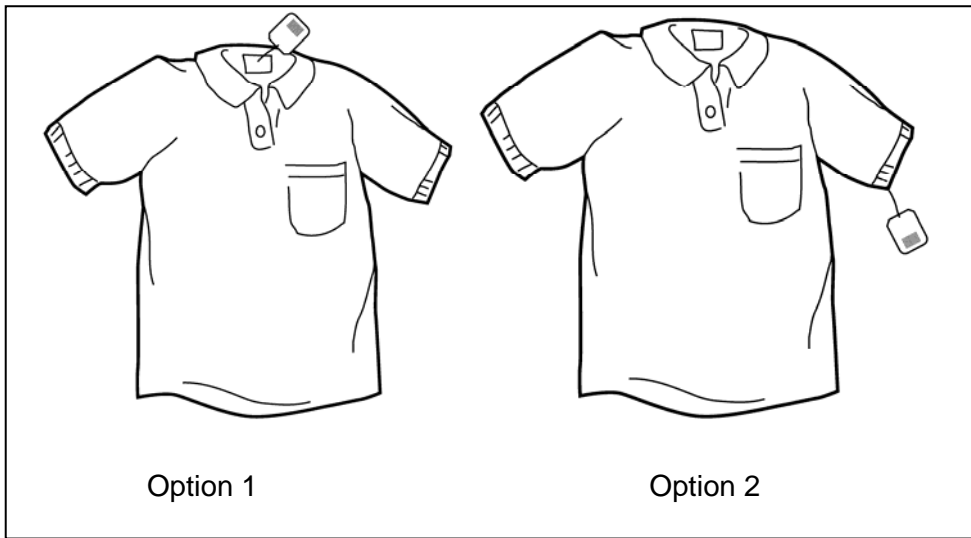
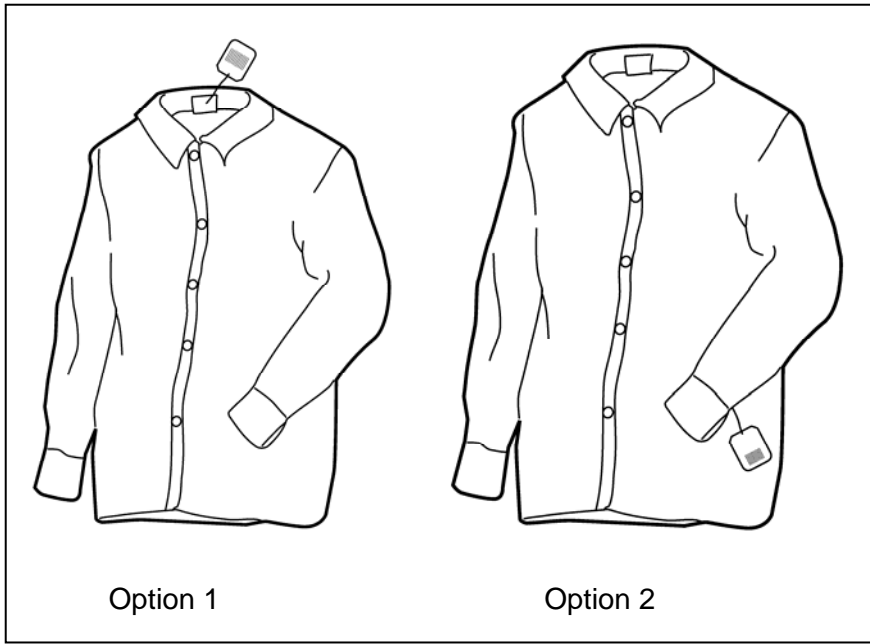
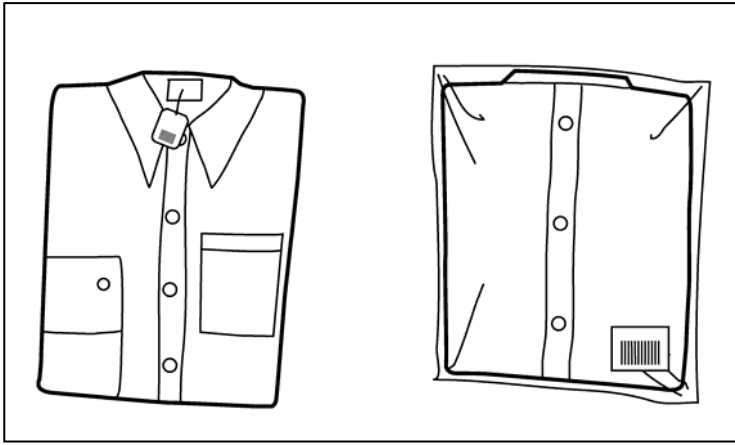

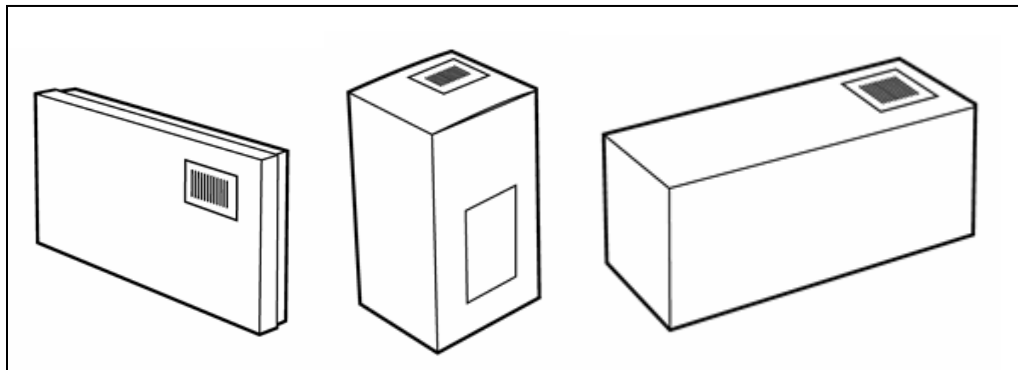
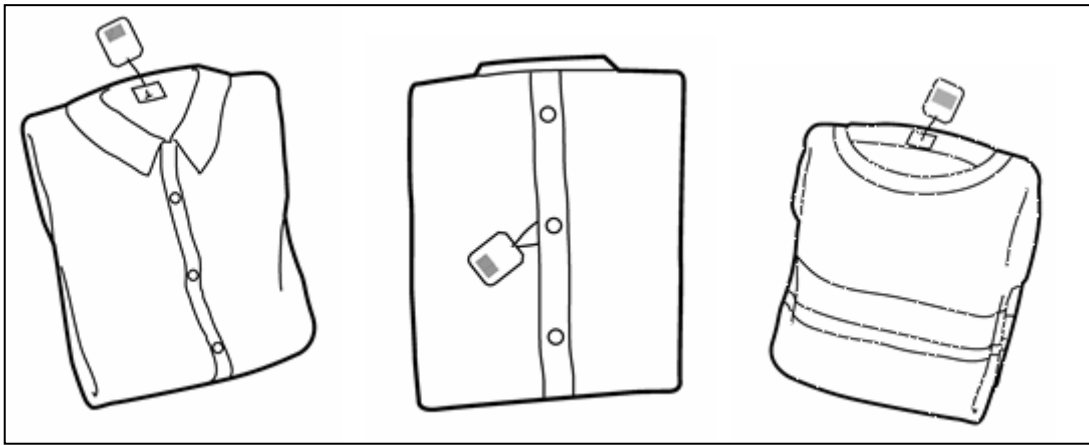
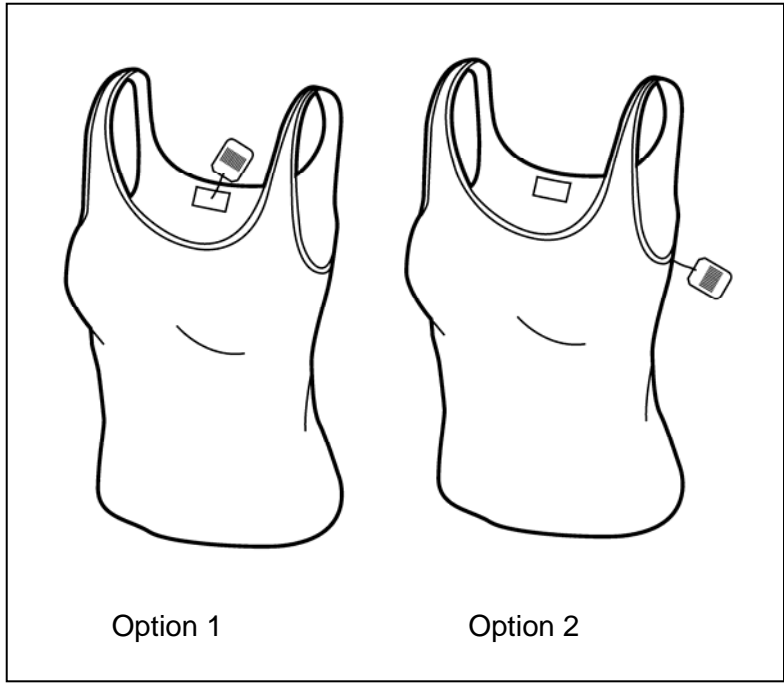

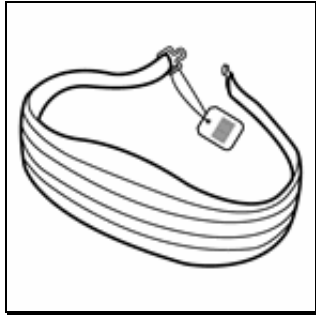

## 6 General Format Guidelines for Clothing and Fashion Accessories

Clothing is displayed in a variety of ways, such as loose (e.g., hanging garments), in boxes, or in bags. In many cases, a relatively small label must carry all the pertinent information relevant to the product. A retail label normally carries not only product-specific information important to the retailer (e.g., die lot, batch) and consumer related information (e.g., style, size, color), but also the bar code symbol itself.

The correct general layout for a retail label is indicated below. Because there are many clothing types on the retail market, detailed label formats are presented later in this section.

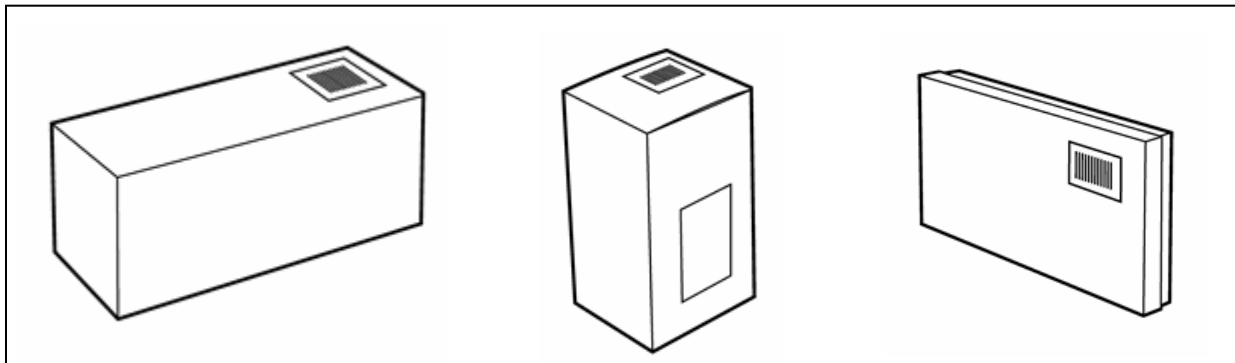

- Layout of label: The label should be divided into three portions:
  - Manufacturer / retailer information: The upper portion of the format is the preferred location for Human Readable Interpretation product identification. This information is important to manufacturers and retailers, but usually not to the consumer.
  - Bar code symbol: The center portion of the format is the best location for the bar code symbol. Symbols in this location are the least likely to present obstructions to scanners because a natural boundary exists between the manufacturer / retailer information (upper portion) and the consumer information (lower portion).
  - Consumer information: The lower portion of the format is the preferred location for information that is provided for the consumer, such as price, size, and fabric content.
- Label placement on clothing and fashion accessories: To determine the placement of the printed label on clothing and fashion accessories, see *Section 5* for drawings that illustrate where to attach or place the label on each type of product.

### 6.1 Information Zones Concept

There are seven information zones that carry product information needed for the vendor, retailer, and consumer. Some information is optional based on the type of label.

### 6.1.1 General Label Information Zones

Zone	Information Type	Description	Status: Required/Optional
1	Merchandise identification	This is the primary human readable merchandise identifier, usually the style number, although it may be pattern, model, or garment type. The merchandise identifier should be located in the upper-left portion of zone 1.	Always required (See Note)
2	Vendor information	This includes optional vendor production information, such as vendor Stock Keeping Unit (SKU), cut number, dye lot, color, and pattern. (Vendor information helps ensure that the correct bar code symbol is attached to the product.)	Optional
3	Data structure	Bar code symbol, GTIN-8, GTIN-12, and GTIN-13	Always required
4	Consumer information	This includes optional product information for the consumer, such as fiber content, fire retardancy, and country of origin.	Optional
5	Size / Dimension	Size / dimension is a key requirement for the consumer. Size information can be emphasized in large bold print and should be located in the right portion of zone 5. Vendors may optionally include a style name as a selection aid for the consumer.	Usually required unless defined by the product (e.g., towels)
6	Retail price	<p>Allow space to print the price with minimum dimension characters of 25 mm (1 in.) x 32 mm (1.25 in.). For plastic packaged, boxed, and banded products, the required space for price can be provided by several methods:</p> <ul style="list-style-type: none"> <li>- For bar code symbol marking on an adhesive label, include the space for price as part of the label.</li> <li>- For bar code symbol marking designed into the packaging, include the space for price on the package artwork.</li> <li>- Providing package space adjacent to zone 5 that is reserved for retail item pricing creates an implied space for price. Implied space replaces the requirement for actual space on labels or package artwork.</li> <li>- If implied space for price is used, no information of importance should be printed in the area that might be covered by adhesive item price labels.</li> </ul>	Usually required unless defined by the ticket format (e.g., sewn-in tickets)

Zone	Information Type	Description	Status: Required/Optional
7	Manufacturer's suggested retail price	This is for use only if merchandise is pre-priced or the suggested retail price is printed on the tag. If provided, the area must be perforated for optional removal.	Optional

**NOTE:** Size and color are optional in zone 1 if vendor usage requires this information to define the product.

### 6.1.2 General Label Format

See the following figures for examples of how the zones appear in a typical vertical and horizontal label format.

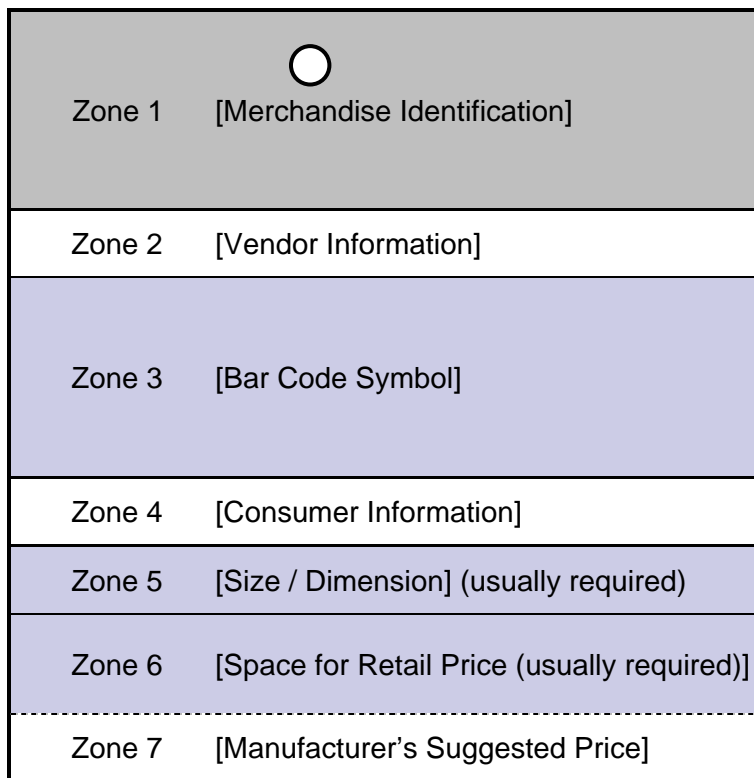

Figure 6.1 – Vertical label format

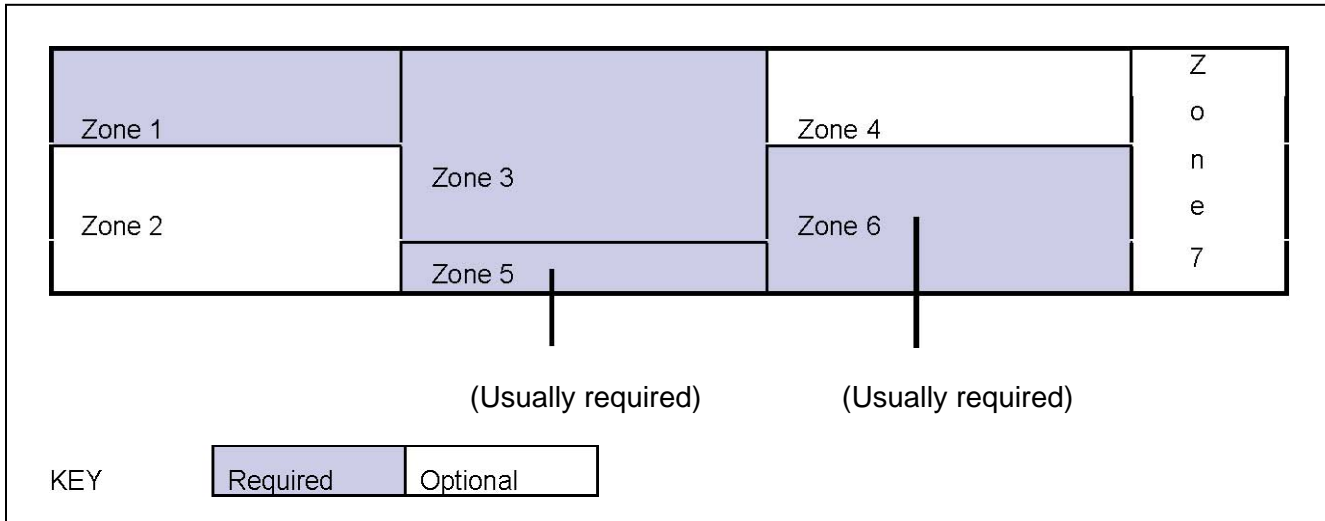

Figure 6.2 – Horizontal label format

## 6.2 Hang Tag (Hanging Label) Format

Although hang tags (hanging labels) are primarily associated with hanging ready-to-wear apparel, a wide variety of products are identified with hang tags. Flat-folded apparel, jewelry, belts, handbags, lamps, and furniture are all identified by some form of hang tag. Therefore, the voluntary hang tag format guidelines outlined in this section provide for flexibility in hang tag design while maintaining the overall concept of the information zones.

Hang tags serve a dual purpose. First, they provide brand identification to the consumer. Second, as the back of a hang tag is frequently used for product information and product identification codes, it should carry the bar code symbol that identifies the product.

The typical hang tag layout features the vendor's logo on the front and product identification codes and the bar code symbol on the back. Vendors may optionally include an additional logo on the back of the hang tags. However, a logo should not appear at the bottom because a retail price label may obscure it or it could be torn off if a manufacturer's suggested retail price is removed. Avoid background printing of logos, as this may obscure required information or important consumer information. Logos must never obscure the bar code symbol.

## 6.2.1 Hang Tag Label Information Zones

Zone	Information Type	Description	Status: Required/Optional
1	Merchandise identification	This is the primary human readable merchandise identifier, usually the style number, although it may be pattern, model, or garment type. The merchandise identifier should be located in the upper-left portion of zone 1.	Always required (See Note)
2	Vendor information	This includes optional vendor production information, such as vendor Stock Keeping Unit (SKU), cut number, dye lot, color, and pattern. (Vendor information helps ensure that the correct bar code symbol is attached to the product.)	Optional
3	Data structure	Bar code symbol, GTIN-8, GTIN-12, and GTIN-13	Always required
4	Consumer information	This includes optional product information for the consumer, such as fiber content, fire retardancy, and country of origin.	Optional
5	Size / Dimension	Size/dimension is a key requirement for the consumer. Size information can be emphasized in large bold print and should be located in the right portion of zone 5. Vendors may optionally include a style name as a selection aid for the consumer.	Usually required unless defined by the product (e.g., towels)
6	Retail price	Allow space to print the price with minimum dimension characters of 25 mm (1 in.) x 32 mm (1.25 in.).	Usually required unless defined by the ticket format (e.g., sewn-in tickets)
7	Manufacturer's suggested retail price	This is for use only if merchandise is pre-priced or the suggested retail price is printed on the tag. If provided, the area must be perforated for optional removal.	Optional

**NOTE:** Size and color are optional in zone 1 if vendor usage requires this information to define the product.



## 6.2.2 Hanging Tag Label Examples

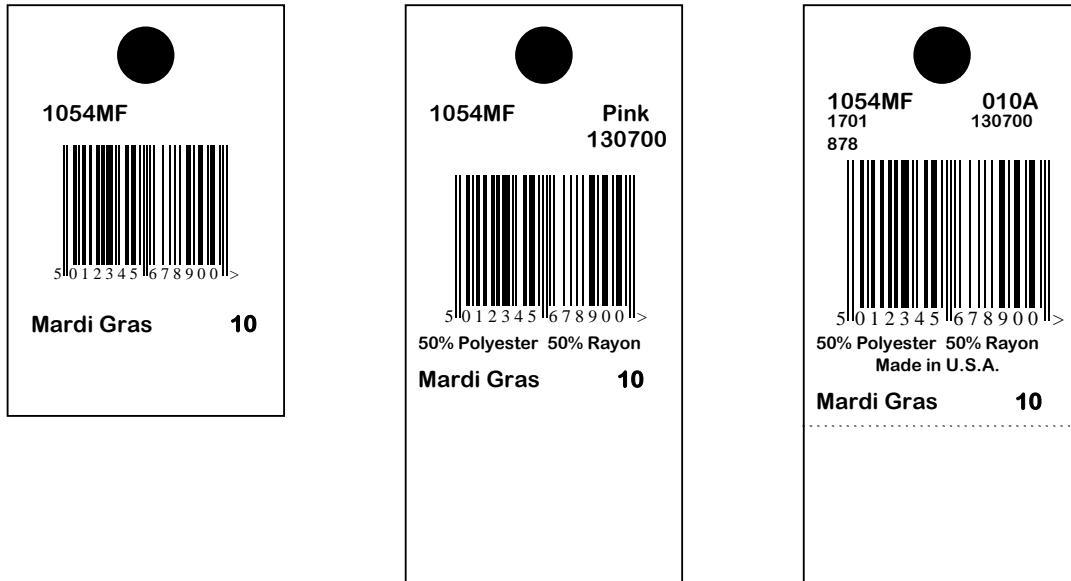

Figure 6.3 – Examples of hanging tag label

## 6.3 Sewn-On (Joker) Label Format

Used almost exclusively for apparel merchandise, joker labels are similar in format to hang tags, but differ in one important respect: They are sewn directly onto the product instead of hung from the product. Because it is sewn on, only one side of the label is available for the vendor's logo, the bar code symbol, and merchandise identification information.

Inclusion of a vendor logo on the label is optional. If it is included, it should not appear at the bottom, because it may be obscured by a retail price label, or it could be torn off by the removal of a manufacturer's suggested retail price. Avoid background printing of logos, as this may obscure required information or important consumer information. Logos must never obscure the bar code symbol.

### 6.3.1 Sewn-On (Joker) Label Information Zones

Zone	Information Type	Description	Status: Required/Optional
1	Merchandise identification	This is the primary human readable merchandise identifier, usually the style number, although it may be pattern, model, or garment type. The merchandise identifier should be located in the upper-left portion of zone 1.	Always required (See Note )
2	Vendor information	This includes optional vendor production information, such as vendor Stock Keeping Unit (SKU), cut number, dye lot, color, and pattern. (Vendor information helps ensure that the correct bar code symbol is attached to the product.)	Optional
3	Data structure	Bar code symbol, GTIN-8, GTIN-12, and GTIN-13	Always required
4	Consumer information	This includes optional product information for the consumer, such as fiber content, fire retardancy, and country of origin.	Optional
5	Size / Dimension	Size / dimension is a key requirement for the consumer. Size information can be emphasized in large bold print and should be located in the right portion of zone 5. Vendors may optionally include a plain language style name on the size line as a selection aid for the consumer.	Usually required unless defined by the product (e.g., towels)
6	Retail price	Allow space to print the price with minimum dimension characters of 25 mm (1 in.) x 32 mm (1.25 in.).	Usually required unless defined by the ticket format (e.g., sewn-in tickets)
7	Manufacturer's suggested retail price	This is for use only if merchandise is pre-priced or the suggested retail price is printed on the tag. If provided, the area must be perforated for optional removal.	Optional

**NOTE:** Size and color are optional in zone 1 if vendor usage requires this information to define the product.

### 6.3.2 Sewn-On (Joker) Label Examples

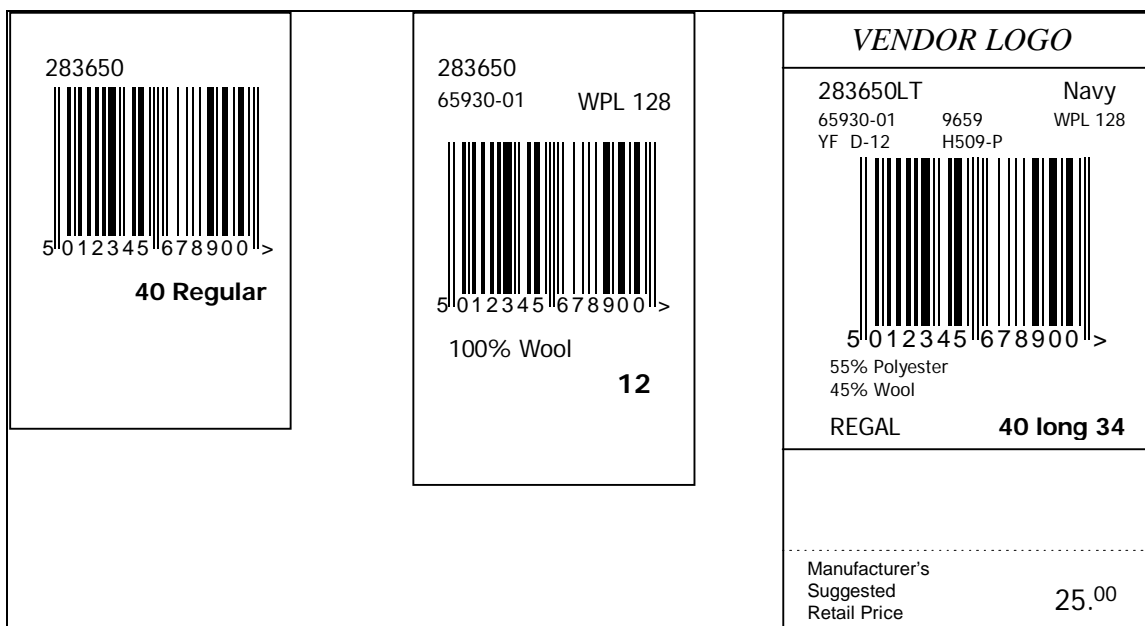

Figure 6.4 – Vertical layout

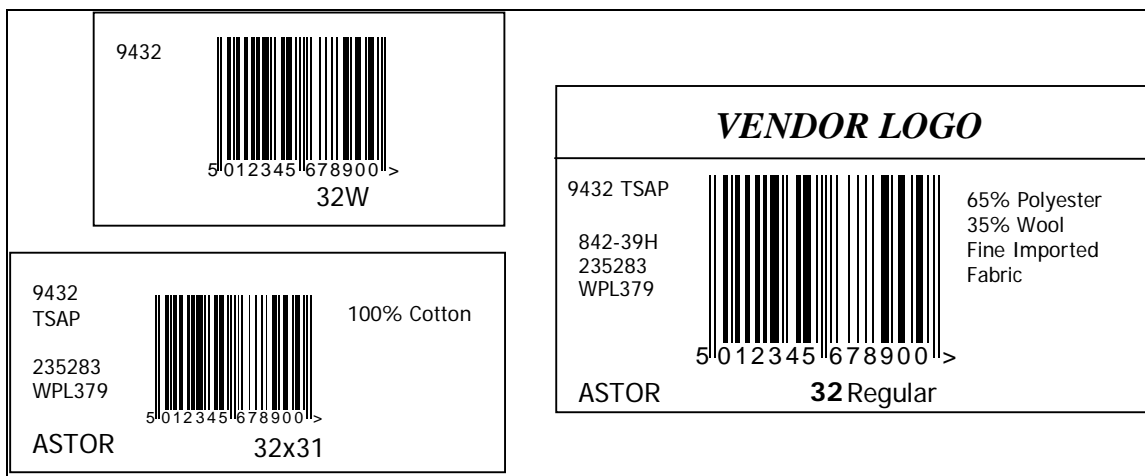

Figure 6.5 – Horizontal layout

### 6.4 Sewn-In Label Formats

Sewn-in labels are often used for towel products. Sewn-in labels may be paper based, for removal by the consumer, or cloth based and more permanent.

Because a portion of the sewn-in label is normally covered by a hem, design the label with sufficient blank space on the end that will be attached to the product. Care must be taken to ensure that the product identification information on the label is not obscured by the hem, and that it does not interfere with the readability of the bar code symbol at the POS.

### 6.4.1 Sewn-In Label Information Zones

Zone	Information Type	Description	Status: Required/Optional
1	Merchandise identification	This is the primary human readable merchandise identifier, usually the style number, although it may be pattern, model, or garment type. The merchandise identifier should be located in the upper left portion of zone 1.	Always required (See Note)
2	Vendor information	This includes optional vendor production information, such as vendor Stock Keeping Unit (SKU), cut number, dye lot, color, and pattern. (Vendor information helps ensure that the correct bar code symbol is attached to the product.)	Optional
3	Data structure	Bar code symbol, GTIN-8, GTIN-12, and GTIN-13	Always required
4	Consumer information	This includes optional product information for the consumer, such as fiber content, fire retardancy, and country of origin.	Optional
5	Size / Dimension	Size / dimension is optional for sewn-in labels. Size or dimension may assist the consumer with product selection or may help the vendor ensure that the correct label and bar code symbol are attached to the product.	Usually required unless defined by the product (e.g., towels) and readily apparent to the consumer.
6	Retail price	Allow space to print the price with minimum dimension characters of 25 mm (1 in.) x 32 mm (1.25 in.).	Usually required unless defined by the ticket format (e.g., sewn-in tickets)
7	Manufacturer's suggested retail price	This is for use only if merchandise is pre-priced or the suggested retail price is printed on the tag. If provided, the area must be perforated for optional removal.	Optional

**NOTE:** Size and color are optional in zone 1 if vendor usage requires this information to define the product.

### 6.5 Plastic Packaged Products Label Location Guidelines

The plastic packaged category covers a wide assortment of merchandise including sheets, pillowcases, table linens, pantyhose, underwear, stationery supplies, pillows, bedspreads, and numerous types of flat-folded apparel that are plastic packaged.

There are two methods of marking plastic packaged products with bar code symbols:

- Incorporate the bar code symbol and other merchandise identification information into the packaging's artwork.

- Print the bar code symbol and other merchandise identification information on an adhesive label that can be press-applied to the product.

Inclusion of a vendor logo on the label is optional. If it is included, the logo should not appear at the bottom, because it may be obscured by a retail price label, or it could be torn off by the removal of a manufacturer's suggested retail price. Avoid background printing of logos as this may obscure required information or important consumer information. Logos must never obscure the bar code symbol.

### 6.5.1 Plastic Packaged Products Label Information Zones

Zone	Information Type	Description	Status: Required/Optional
1	Merchandise identification	This is the primary human readable merchandise identifier, usually the style number, although it may be pattern, model, or garment type. The merchandise identifier should be located in the upper-left portion of zone 1.	Always required (See Note 1)
2	Vendor information	This includes optional vendor production information, such as vendor Stock Keeping Unit (SKU), cut number, dye lot, color, and pattern. (Vendor information helps to ensure that the appropriate bar code symbol is attached to the product.)	Optional
3	Data structure	Bar code symbol, GTIN-8, GTIN-12, and GTIN-13	Always required
4	Consumer information	This includes optional product information for the consumer, such as fiber content, fire retardancy, and country of origin.	Optional (See Note 2)
5	Size / Dimension	Size / dimension is a key requirement for the consumer. Size information can be emphasized in large bold print and should be located in the right portion of zone 5. Vendors may optionally include a style name as a selection aid for the consumer.	Usually required (See Note 3)

Zone	Information Type	Description	Status: Required/Optional
6	Retail price	Allow space to print the price with 25 mm (1 in.) x 32 mm (1.25 in.) minimum dimension characters. For plastic packaged products, this required space for price can be provided by several methods: <ul style="list-style-type: none"> <li>- For bar code symbol marking on an adhesive label, include the space for price as part of the label.</li> <li>- For bar code symbol marking designed into the packaging, include the space for price on the package artwork.</li> <li>- Providing package space adjacent to zone 5 that is reserved for retail item pricing creates an implied space for price. Implied space replaces the requirement for actual space on labels or package artwork.</li> <li>- If implied space for price is used, no information of importance should be printed in the area that might be covered by adhesive item price labels.</li> </ul>	Usually required
7	Manufacturer's suggested retail price	This is for use only if merchandise is pre-priced or the suggested retail price is printed on the tag. If provided, the area must be perforated for optional removal.	Optional

**NOTE 1:** Size and color are optional in zone 1 if vendor usage requires this information to define the product.

**NOTE 2:** Some jurisdictions require that certain products include a permanently affixed statement of information of this type in zone 4 that may not be satisfied by inclusion on the package.

**NOTE 3:** Size may be omitted from zone 5 if the size information is readily available on the product packaging.

### 6.5.2 Plastic Packaged Products Label Placement Guidelines

Consistent bar code symbol placement is required for successful scanning at the POS. The symbol placement guidelines for plastic packaged products have been designed with the flexibility to accommodate differences that may arise from industry to industry:

- On plastic packaged products, the front top-right corner is the preferred placement for the bar code symbol and other product identification information.
- The bar code symbol and other product identification information may be located on the front or back of plastic packaged products. However, all products within a particular merchandise category must have their bar code symbols placed on the same side of the package.

**Caution:** Placement of the bar code symbol on the back of a product may result in the presentation of the product on the display counter in a backside up orientation by some retailers so that the bar code symbol and retail price appear together in full view by the customer.

- The orientation of the bar code symbol and other product identification information should be consistent with any graphics or descriptive data on the plastic package.
- The symbol and other product identification information, whether built into the package artwork or an adhesive label, must not be closer than 8 mm (0.3 inches) or farther than 102 mm (4 inches) from any edge of the package. Experience has shown that the previously recommended minimum distance of 5 mm (0.2 inches) is inadequate. Also, cashiers often grab packages on the edge with their thumbs. Avoid placing the bar code symbol too close to the edge. Such placement reduces POS efficiency and may cause distortion of the symbol. [The bar code symbol cannot be closer than 8 mm (0.3 inches) or farther than 100 mm (4 inches) from any edge of the package / container.]
- The bar code symbol and other product identification information on plastic packaged products should typically be located on the front top-right corner. However, for very large, bulky, or unusually shaped products, this may be impractical or inappropriate. See Section 4.9 for information on large, heavy, and bulky items.

**NOTE:** Section 4 specifies the lower-right quadrant of the back of the package or container as the recommended location for the bar code symbol. This recommendation remains in effect for plastic packaged products that are sold in a grocery store environment.

### 6.5.3 Plastic Packaged Products Label Example

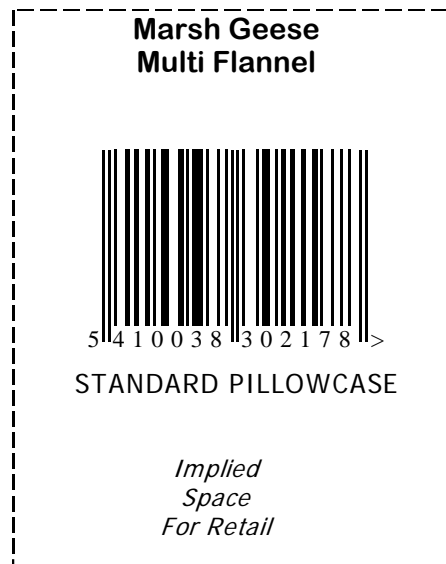

Figure 6.6 – Example of plastic packaged product label

## 6.6 Boxed Products Label Formats

Some boxed products may be sold in or out of the box. Other boxed products are actually sets that may also be sold as individual items. Some boxes carry significant amounts of design graphics, while others are simply cardboard boxes containing the product.

Box size can range from very small, as in jewelry or cosmetics, to very large, as in home furnishings. For extremely large boxed products, consider using a two-part tear-off bar code symbol label to facilitate scanning at the POS while leaving one label on the box.

There are two methods of marking boxed products with bar code symbols:

- Incorporate the bar code symbol and other merchandise identification information the box's artwork.
- Print the bar code symbol and other merchandise identification information on an adhesive label that can be affixed to the box.

Inclusion of a vendor logo in the box marking format is optional. If the logo is included, it should not appear at the bottom, because it may be obscured by a retail price label, or it could be torn off if a manufacturer's suggested retail price is removed. Avoid background printing of logos, as this may obscure required information or important consumer information.

### 6.6.1 Boxed Products Label Information Zones

Zone	Information Type	Description	Status: Required/Optional
1	Merchandise identification	This is the primary human readable merchandise identifier, usually the style number, although it may be pattern, model, or garment type. The merchandise identifier should be located in the upper-left portion of zone 1.	Always required (See Note 1)
2	Vendor information	This includes optional vendor production information, such as vendor Stock Keeping Unit (SKU), cut number, dye lot, color, and pattern. (Vendor information helps ensure that the correct bar code symbol is attached to the product.)	Optional
3	Data structure	Bar code symbol, GTIN-8, GTIN-12, and GTIN-13	Always required
4	Consumer information	This includes optional product information for the consumer, such as fiber content, fire retardancy, and country of origin.	Optional (See Note 2)
5	Size / Dimension	Size / dimension is a key requirement for the consumer. Size information can be emphasized in large bold print and should be located in the right portion of zone 5. Vendors may optionally include a style name as a selection aid for the consumer.	Usually required (See Note 3)



Zone	Information Type	Description	Status: Required/Optional
6	Retail price	Allow space to print the price with minimum dimension characters of 25 mm (1 in.) x 32 mm (1.25 in.). For boxed products, this required space for price can be provided by several methods: <ul style="list-style-type: none"> <li>- For bar code symbol marking on an adhesive label, include the space for price as part of the label.</li> <li>- For bar code symbol marking designed into the packaging, include the space for price on the package artwork.</li> <li>- Providing package space adjacent to zone 5 that is reserved for retail item pricing creates an implied space for price. Implied space replaces the requirement for actual space on labels or package artwork.</li> <li>- If implied space for price is used, no information of importance should be printed in the area that might be covered by adhesive item price labels.</li> </ul>	Usually required
7	Manufacturer's suggested retail price	For use only if merchandise is pre-priced or the suggested retail price is printed on the tag. If provided, the area must be perforated for optional removal.	Optional

**NOTE 1:** Size and color are optional in zone 1 if vendor usage requires this information to define the product.

**NOTE 2:** Some jurisdictions require that certain products include a permanently affixed statement of information of this type in zone 4 that may not be satisfied by inclusion on the package.

**NOTE 3:** Size may be omitted from zone 5 if the size information is readily available on the product packaging.

### 6.6.2 Packaged Versus Freestanding Single Selling Units

Certain single selling units (trade items) may be sold as freestanding items, or they may be sold in a package. This creates a dilemma for the supplier. Mark the item or mark the package? For GTIN Allocation Rules pertaining to this scenario, see *Section 2*.

### 6.6.3 Boxed Products Label Placement Guidelines

Consistent bar code symbol placement within an industry or product category is required if merchandise carrying a bar code symbol is to successfully scan at the POS. Since the category of boxed products includes a diverse merchandise group, location guidelines have been

designed with considerable flexibility to accommodate differences that may arise from industry to industry:

- The exposed surface of the box is the preferred location for bar code symbols and other product identification information on boxed products sold primarily in the department or specialty store environment.
- The orientation of the bar code symbol and other product identification information should be consistent with any graphics or descriptive data on the box.
- The symbol and other product identification information, whether built into the package artwork or an adhesive label, must not be closer than 8 mm (0.3 inches) or farther than 102 mm (4 inches) from any edge of the package. Experience has shown that the previously recommended minimum distance of 5 mm (0.2 inches) is inadequate. Also, cashiers often grab packages on the edge with their thumbs. Avoid placing the bar code symbol too close to the edge. Such placement reduces POS efficiency and may cause distortion of the symbol. [The bar code symbol cannot be closer than 8 mm (0.3 inches) or farther than 100 mm (4 inches) from any edge of the package / container.]
- The bar code symbol and other product identification information on plastic packaged products should typically be located on the front top-right corner. However, for very large, bulky, or unusually shaped products, this may be impractical or inappropriate. See *Section 4.9* for information on large, heavy, and bulky items.

**NOTE:** *Section 6.5* specifies the lower-right quadrant of the back of the package or container as the recommended location of the bar code symbol. This recommendation remains in effect for plastic packaged products that are sold in a grocery store environment.

## 6.6.4 Boxed Products Label Examples

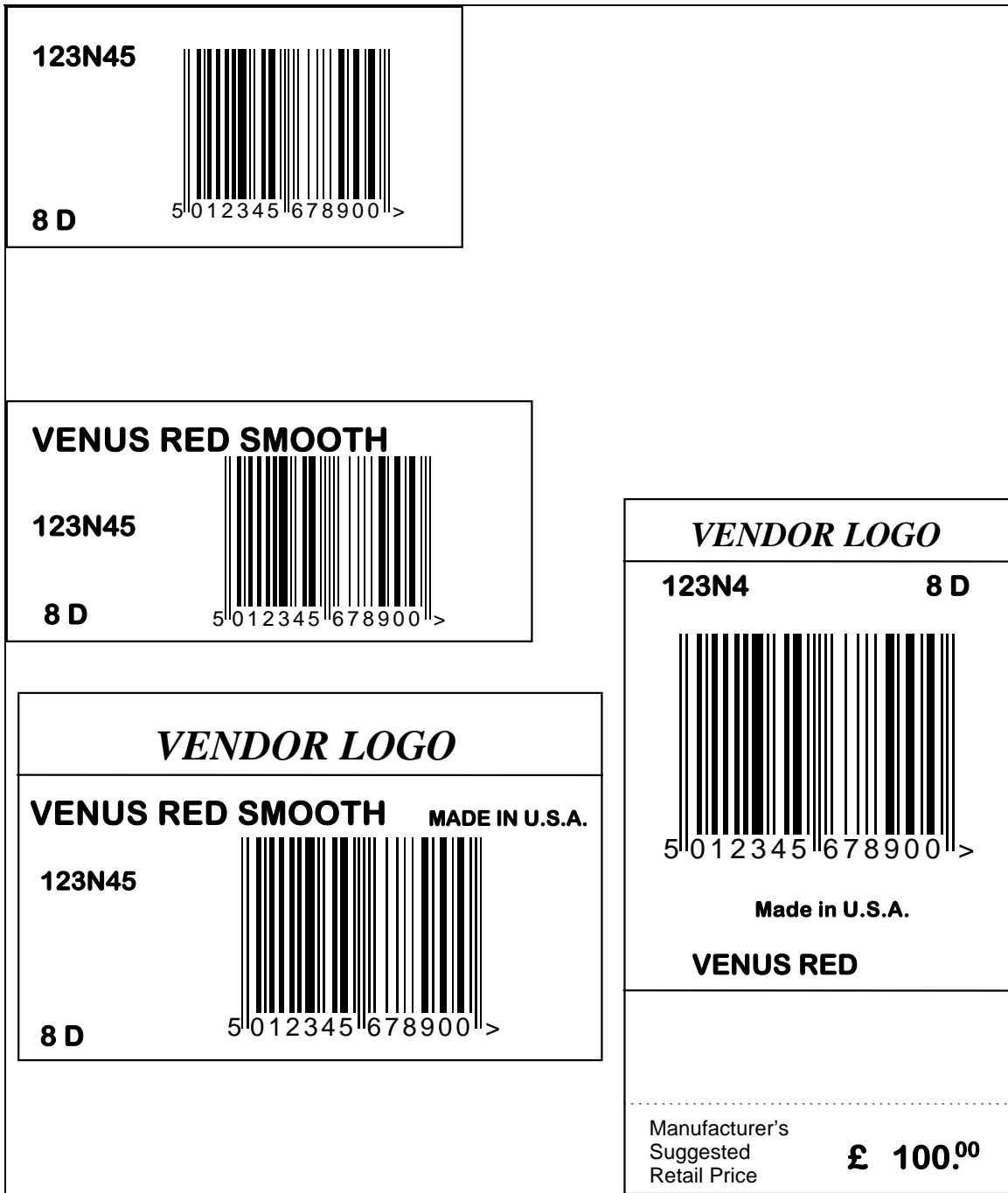

Figure 6.7 – Examples of boxed products labels

## 6.7 Banded Products Label Formats

Banded packaging involves a specialized group of products. This type of packaging is most commonly associated with hosiery (socks) or yarn products.

There are the two methods of marking banded products with bar code symbols:

- Incorporate the bar code symbol and other merchandise identification information into the band's artwork.
- Print the bar code symbol and other merchandise identification information on an adhesive label that can be applied to the band.

The typical banded product label features the vendor's logo on the front while the back contains product identification codes, consumer information, and the bar code symbol. The vendor's logo can also be printed on the back of the band as part of the band marking format. However, care should be taken to ensure that there is no obstruction of the bar code symbol or other important product identification information. Avoid background printing of logos also.

### 6.7.1 Banded Products Label Information Zones

Zone	Information Type	Description	Status: Required/Optional
1	Merchandise identification	This is the primary human readable merchandise identifier, usually the style number, although it may be pattern, model, or garment type. The merchandise identifier should be located in the upper-left portion of zone 1.	Always required (See Note 1)
2	Vendor information	This includes optional vendor production information, such as vendor Stock Keeping Unit (SKU), cut number, dye lot, color, and pattern. (Vendor information helps ensure that the correct bar code symbol is attached to the product.)	Optional
3	Data structure	Bar code symbol, GTIN-8, GTIN-12, and GTIN-13	Always required
4	Consumer information	This includes optional product information for the consumer, such as fiber content, fire retardancy, and country of origin.	Optional (See Note 2)
5	Size / Dimension	Size / dimension is a key requirement for the consumer. Size information can be emphasized in large bold print and should be located in the right portion of zone 5. Vendors may optionally include a style name as an aid to the consumer in selection.	Usually required (See Note 3)

Zone	Information Type	Description	Status: Required/Optional
6	Retail price	<p>Allow space to print the price with minimum dimension characters of 25 mm (1 in.) x 32 mm (1.25 in.). For banded products, this required space for price can be provided by several methods:</p> <ul style="list-style-type: none"> <li>- For bar code symbol marking on an adhesive label, include the space for price as part of the label.</li> <li>- For bar code symbol marking designed into the packaging, include the space for price on the package artwork.</li> <li>- Providing package space adjacent to zone 5 that is reserved for retail item pricing creates an implied space for price. Implied space replaces the requirement for actual space on labels or package artwork.</li> <li>- If implied space for price is used, no information of importance should be printed in the area that might be covered by adhesive item price labels.</li> </ul>	Usually required
7	Manufacturer's suggested retail price	This is for use only if merchandise is pre-priced or the suggested retail price is printed on the tag. If provided, the area must be perforated for optional removal.	Optional

**NOTE 1:** Size and color are optional in zone 1 if vendor usage requires this information to define the product.

**NOTE 2:** Some jurisdictions require that certain products include a permanently affixed statement of information of this type in zone 4 that may not be satisfied by inclusion on the package.

**NOTE 3:** Size may be omitted from zone 5, if the size information is readily available on the product packaging.

## **7 General Placement Guidelines for Items Used in Distribution**

General distribution items include any item handled as a single unit in the transport and distribution process. This definition covers a wide variety of package types, such as pallets, cartons, cases, bins, and totes. These items can be trade items and / or logistic units.

Bar code scanning may be carried out manually or automatically and the recommended symbol location cannot be optimized for one or the other in an open supply chain scenario. These guidelines have been prepared with the objective to reduce overall supply chain cost but in the full knowledge that implementation will only be driven by a proven (supply-chain) business case.

### **7.1 General Rule**

The bar codes on units intended for general distribution should be upright (in picket fence orientation) and placed on the sides of the unit. Each item should have at least one bar code, and two are recommended when these symbols are pre-printed.

As not all products are packed in an identical way, this general rule may not apply to unusual packaging types (e.g., low height items, display cases, bags).

The bar codes should be kept away from any vertical edges so that the bar codes are less likely to be accidentally damaged in transit.

#### **7.1.1 Symbol Placement on Pallets**

For all types of pallets, including full pallets containing individual trade items and single trade items, (such as a refrigerator or washing machine), the target height for the bottom of the bar code symbol is between 400 mm (16 inches) and 800 mm (32 inches) from the base of the pallet. For a pallet less than 400 mm (16 inches) high, place the bar code symbol as high as possible while protecting the bar code.

The symbol including, its Quiet Zones, should be at least 50 mm (2.0 inches) from any vertical edge to avoid damage.

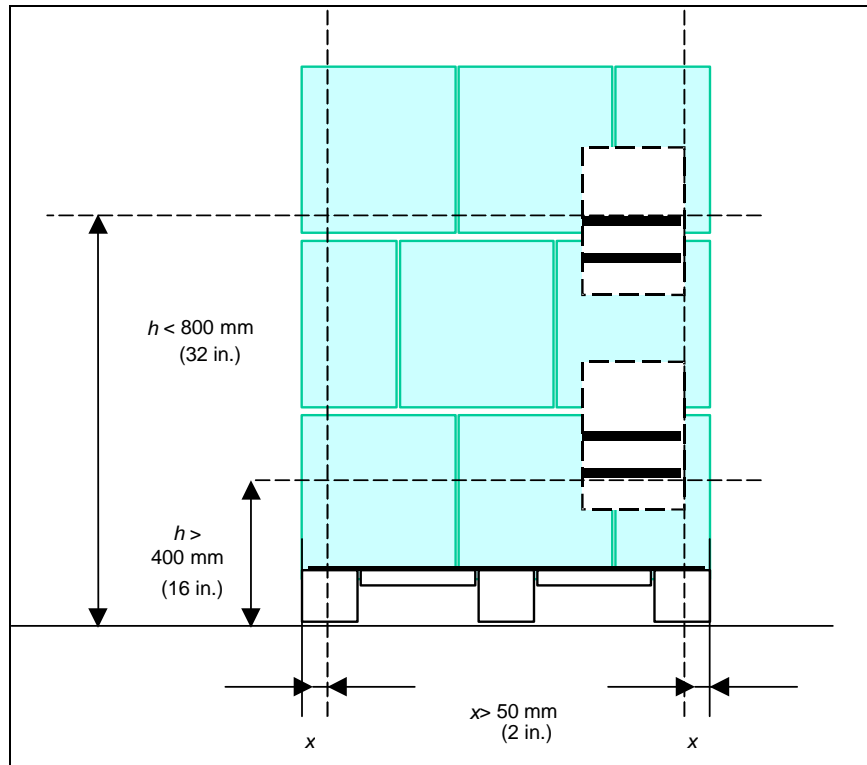

Figure 7.1 – Symbol placement on a pallet

### 7.1.2 Symbol Placement on Cartons and Outer Cases

For cartons and outer cases, symbol placement will vary slightly in practice, however the target placement for the bottom of the bar code symbol is 32 mm (1.25 inches) from the natural base of the item. The symbol including its Quiet Zones should be at least 19 mm (0.75 inches) from any vertical edge to avoid damage.

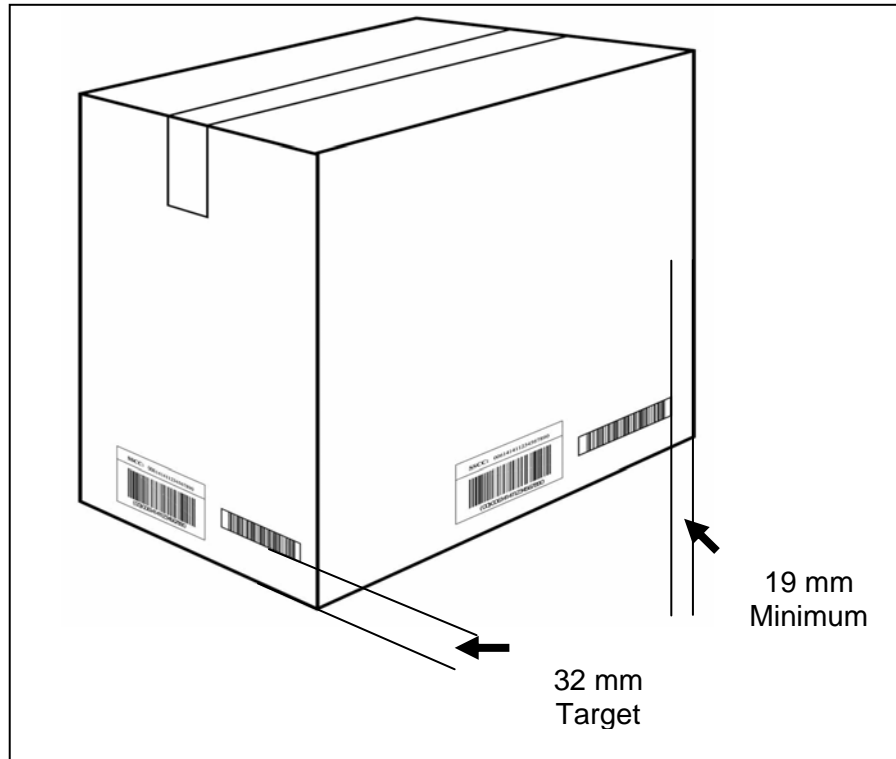

Figure 7.2 – Symbol placement on cartons and outer cases

### 7.1.3 Symbol Location on Shallow Trays and Cases

If the height of a case or tray is less than 50 mm (2.0 inches), making it impossible to print a full height bar code with the Human Readable Interpretation below the bars, or if the construction of the unit is such that the full symbol height cannot be accommodated, the following options should be considered in this order of preference:

1. Place the Human Readable Interpretation to the left of the symbol, outside the compulsory Quiet Zones.

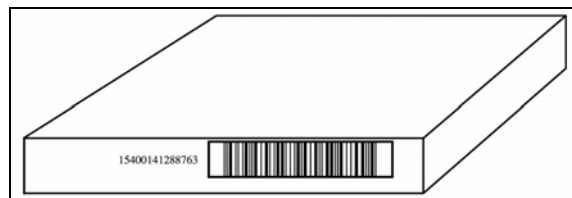

Figure 7.3 – Human readable text to left of symbol

2. When the height of the unit is less than 32 mm, the symbol may be placed at the top of the package. The symbol should be placed with the bars perpendicular to the shortest side, no closer than 19 mm (0.75 inches) from any edge.





Figure 7.4 – Human readable text to left of symbol

Sometimes two bar code symbols are used on variable measure units. If it is necessary to remove the Human Readable Interpretation from beneath the unit, the human readable characters of the main symbols should be placed to the left of the bars of the main symbol. The Human Readable Interpretation of the Add-On Symbol should be placed to the right of the bars of the Add-On Symbol.

#### 7.1.4 Recommendation to Bar Code Two Sides

Although at least one side of all general distribution items should display the bar coded information, it is recommended that two (or more) sides of the item be bar coded with the same data when:

- The printing process makes this cost effective (e.g., pre-printed corrugated cartons).
- The supply chain requirement is that one symbol is always visible (e.g., pallets that are stored either long or short edge facing).

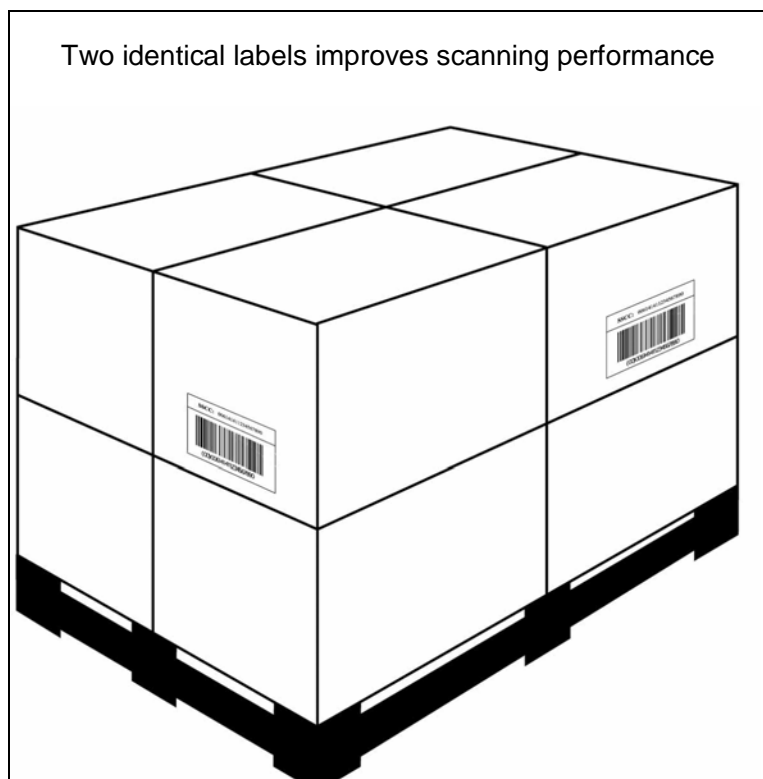

Figure 7.5 – Two (or more) identical bar code symbols

## 7.2 Add-On Symbols

If the unit is already marked with a symbol, place any Add-On Symbol so as not to obscure the primary bar code symbol. The preferred location for the symbol in this case is to the side of the primary code symbol, so that a consistent horizontal location is maintained. Maintain Quiet Zones for both symbols.

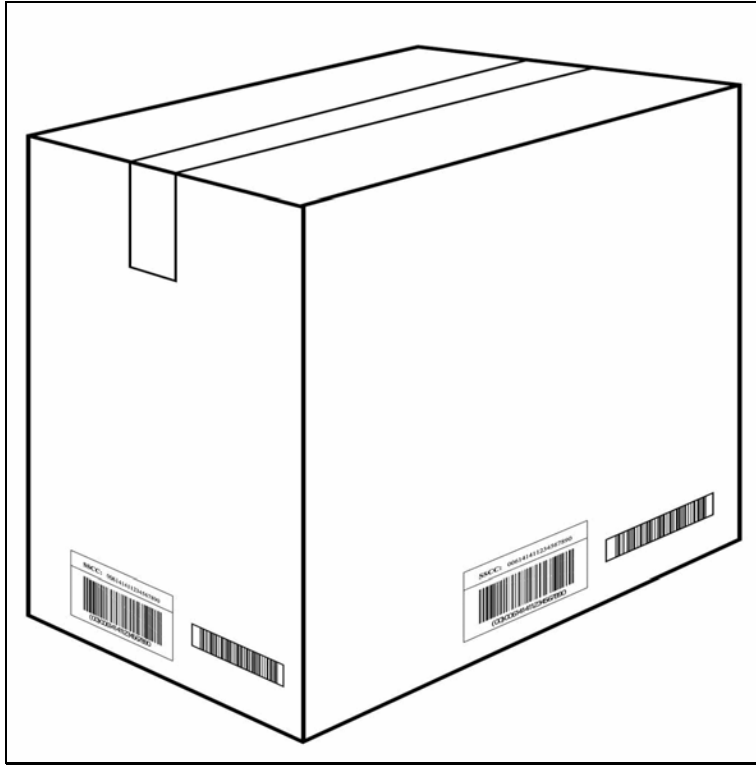

Figure 7.6 – Example showing Add-On Symbols

If there is the potential for both parts of the data content to be represented in a GS1-128 bar code symbol, they should be concatenated and one symbol produced. Bar code symbols containing data essential for complete product identification (e.g., trade measurements) should always be aligned with and to the right of the bar code symbol containing the Global Trade Item Number (GTIN), the primary symbol.

## Appendix A: General Rules for Curved Surfaces

If a bar code symbol is printed on a curved surface, it is preferable for the bars to be perpendicular to the generating lines of the surface of the container (so that a scan line can pass through the symbol on as near a flat plane as possible). See the following figure.

This preference may be subject to space considerations and to the direction of printing. Better printing quality is typically obtained when the bars are parallel to the direction of printing.

The text and orientation of the ladder orientation bar code symbol can be read either from the top down or from the bottom up, whichever is consistent with other text and graphics on the container. Empirical data has demonstrated that it makes no difference one way or the other.

This preference for orientation on curved surfaces becomes a mandatory rule on curves with small radii. The angle between the tangent to the center of the curved symbol and the tangent to the extremity of the curved symbol (outer edge of the guard bars for symbol in the EAN/UPC Symbology) must be less than 30 degrees. If this angle is more than 30 degrees, the symbol must be oriented such that the bars are perpendicular to the generating lines of surface of the item. This is diagrammed in *Figure A.2*.

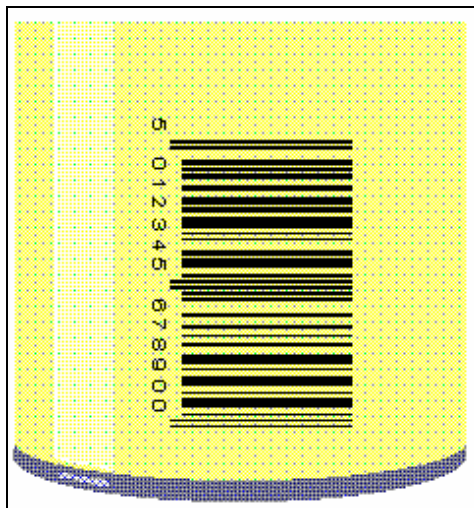

Figure A.1 – Bar code symbol orientation on curved surfaces

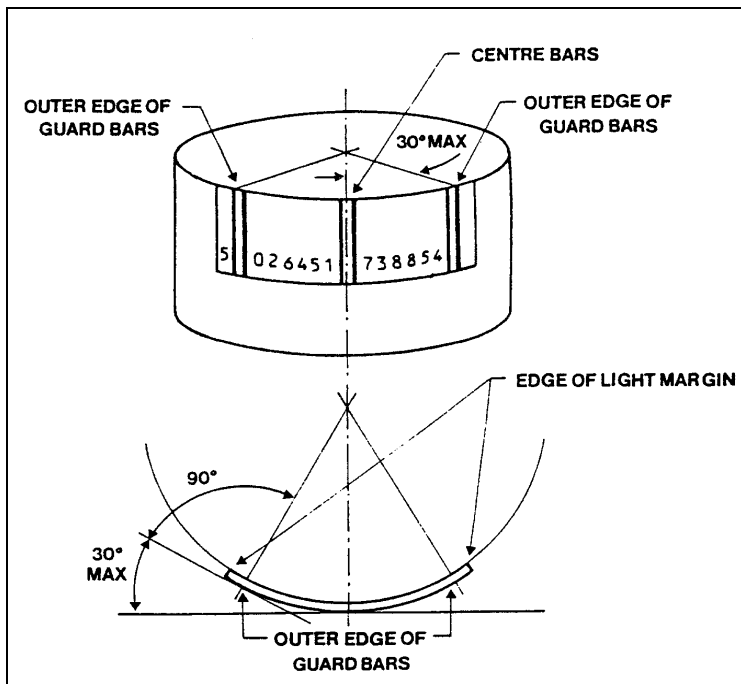

Figure A.2 – Relationship between symbol and curvature

The following figures show the relationship between acceptable X-dimensions for units of different diameters and the minimum diameters for different X-dimensions.

Diameter of Container (cm)	Diameter of Container (in.)	Maximum Value of X-dimension			
		EAN-13 or UPC-A Bar Code Symbol		EAN-8 Bar Code Symbol	
		X-dimension		X-dimension	
		mm	Thousandths of an Inch	mm	Thousandths of an Inch
3 cm or below	1.18	*	*	*	*
3.5	1.38	*	*	.274	12.0
4.0	1.57	*	*	.314	12.4
4.5	1.77	*	*	.353	13.9
5.0	1.97	.274	10.8	.389	15.3
5.5	2.16	.304	12.0	.429	16.9
6.0	2.36	.330	13.0	.469	18.5
6.5	2.56	.356	14.0	.508	20.0
7.0	2.75	.386	15.2	.549	21.6
7.5	2.95	.413	16.3	.587	23.2
8.0	3.25	.446	17.4	.627	24.7
8.5	3.35	.469	18.5	.660	26.0
9.0	3.54	.495	19.5	.660	26.0
9.5	3.74	.525	20.7	.660	26.0
10.0	3.94	.551	21.7	.660	26.0
10.5	4.13	.578	22.8	.660	26.0
11.0	4.33	.607	23.9	.660	26.0
11.5	4.53	.634	25.0	.660	26.0
12 cm or above	4.72	.660	26.0	.660	26.0

Figure A.3 – Relationship between the diameter and x-dimension

**NOTE 1:** The X-dimension necessary for the 30 degree constraint to be respected is smaller than acceptable standards permit (less than 0.8). Hence the symbol will have to be rotated through an angle of 90 degrees.

**NOTE 2:** An asterisk (\*) indicates that the package diameter is too small to permit a picket fence orientation bar code symbol, and the symbol must be rotated 90 degrees to a ladder orientation.

X-dimension		Minimum Diameter of Container			
X-dimension (Thousandths of an Inch)	X-dimension (mm)	EAN-13 or UPC-A Bar Code Symbol (cm)	EAN-13 or UPC-A Bar Code Symbol (in.)	EAN-8 Bar Code Symbol (cm)	EAN-8 Bar Code Symbol (in.)
10.4	.264	4.8	1.89	3.4	1.34
11.7	.297	5.4	2.13	3.8	1.50
13.0	.330	6.0	2.36	4.3	1.69
14.3	.363	6.6	2.60	4.7	1.85
15.6	.396	7.3	2.87	5.1	2.01
16.7	.429	7.8	3.07	5.5	2.16
18.2	.462	8.4	3.31	5.9	2.32
19.5	.495	9.0	3.54	6.4	2.52
20.8	.528	9.6	3.78	6.8	2.68
22.1	.561	10.3	4.05	7.3	2.87
23.4	.594	10.8	4.25	7.6	2.99
24.7	.627	11.4	4.49	8.0	3.25
26.0	.660	12.0	4.72	8.5	3.35

Figure A.4 – Relationship between the X-dimension and diameter

Diameter of Container (cm)	Diameter of Container (in.)	Maximum Value of X-Dimension					
		Global Trade Identification Number (GTIN) in ITF-14 Bar Code Symbol		GTIN in GS1-128 Bar Code Symbol		SSCC in GS1-128 Bar Code Symbol	
		mm	Thousandths of an Inch	mm	Thousandths of an Inch	mm	Thousandths of an Inch
6.0	2.36	*	*	*	*	*	*
8.0	3.25	*	*	*	*	*	*
10.0	3.94	*	*	*	*	*	*
12.0	4.72	*	*	*	*	*	*
14.0	5.51	*	*	*	*	*	*
16.0	6.30	*	*	*	*	*	*
18.0	7.09	.254	10.0	*	*	*	*
20.0	7.87	.284	11.2	.257	10.1	*	*
22.0	8.66	.310	12.2	.284	11.2	*	*
24.0	9.45	.340	13.4	.310	12.2	*	*
26.0	10.24	.366	14.4	.337	13.3	*	*
28.0	11.02	.393	15.5	.360	14.2	*	*
30.0	11.81	.429	16.9	.386	15.2	*	*
32.0	12.60	.429	16.9	.429	16.9	*	*
34.0	13.38	.429	16.9	.429	16.9	*	*
≥ 36.0	≥ 14.17	.429	16.9	.429	16.9	*	*

Figure A.5 – Relationship between the diameter and X-dimension

**NOTE:** An asterisk (\*) indicates that the package diameter is too small to permit a picket fence orientation bar code symbol, and the symbol must be rotated 90 degrees to a ladder orientation.



**CORPORATE HEADQUARTERS**

Princeton Pike Corporate Center  
1009 Lenox Drive, Suite 202  
Lawrenceville, New Jersey 08648 USA

**CUSTOMER SERVICE**

7887 Washington Village Drive, Suite 300  
Dayton, OH 45459-8605 USA  
T +1 937.435.3870  
F +1 937.435.7317  
email: [info@gs1us.org](mailto:info@gs1us.org)

[www.gs1us.org](http://www.gs1us.org)